

NISSAN 100 NX 1600 16V COUPE' 1597cc 70KW 10/90- 92

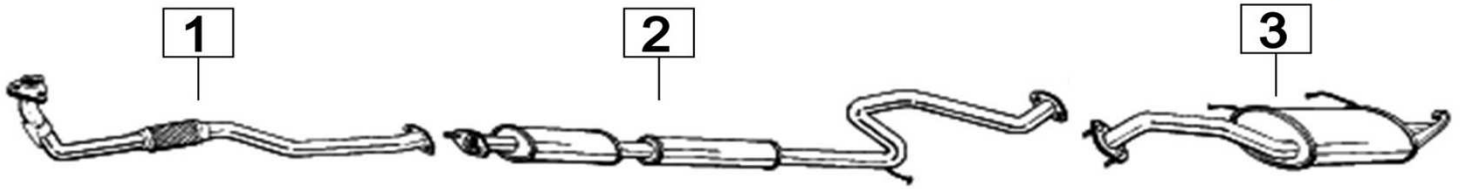

380078

	Codice	Descr.	O.E.	NOTE	Cod. Accessori
1	7524400	T C	2001065Y01		A
2	7524436	M C	2003057Y16		B
3	7524407	M P	2010057Y70 2010057Y71 2010057YX1		C

NISSAN 100 NX 1600 16V COUPE' CATALIZZATA 1597cc 70KW 10/90- 96

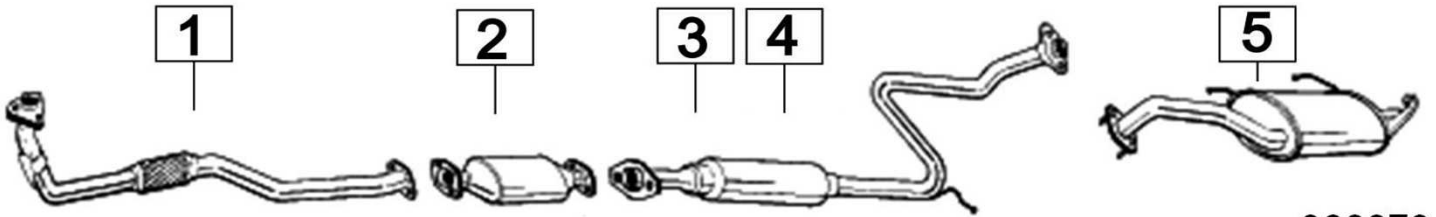

380079

	Codice	Descr.	O.E.	NOTE	Cod. Accessori
1	7524400	T C	2001065Y01		A
2	7521112	KAT	2080070J25 2080076J25		B
3	7524406	M C	B003M65Y0FGA		C
4	7524446	M C	B003M65Y2AGA	dal 10/1992	D
5	7524407	M P	2010057Y70 2010057Y71 2010057YX1		E

NISSAN 100 NX 2000 GTi SPORT/COUPE' Mot:SR20DE 1998cc 105KW 10/90- 95

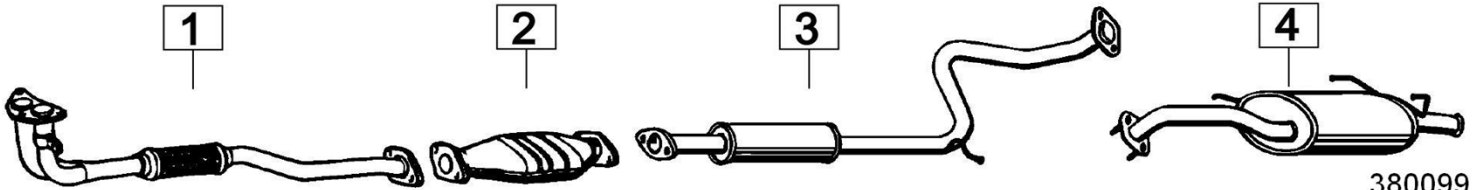

380099

	Codice	Descr.	O.E.	NOTE	Cod. Accessori
1	7524450	T C	2002035Y01		A
2	7507712	KAT	2008074C28		B
3	7524456	M C	2003058Y00		C
4	7524457	M P	2010058Y70		D

NISSAN 200 SX TURBO 16V 1809cc 124KW 9/88-

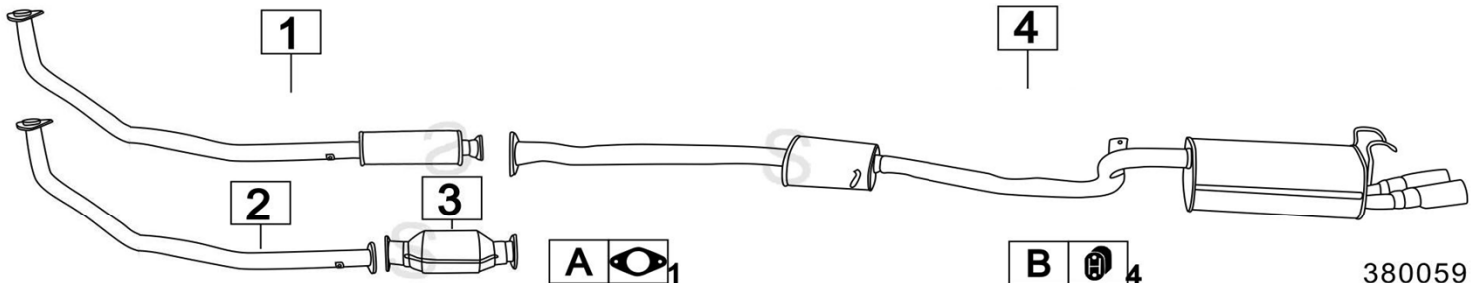

380059

	Codice	Descr.	O.E.	NOTE	Cod. Accessori
1	7524302	M A	2001044F00 - 2001044F01 - B001044F01		A 2130933
2	7524300	T C	2001044F10 - 2001044F20		B 2743901
3	7521112	KAT	2080074C28 - 2080040F28 - 2080040F25		C
4	7524309	G M	2010044F00-2010044F02		D

NISSAN 200 SX TURBO 16V Mot.SR20DET 1998cc 145KW 4/94- 9/99

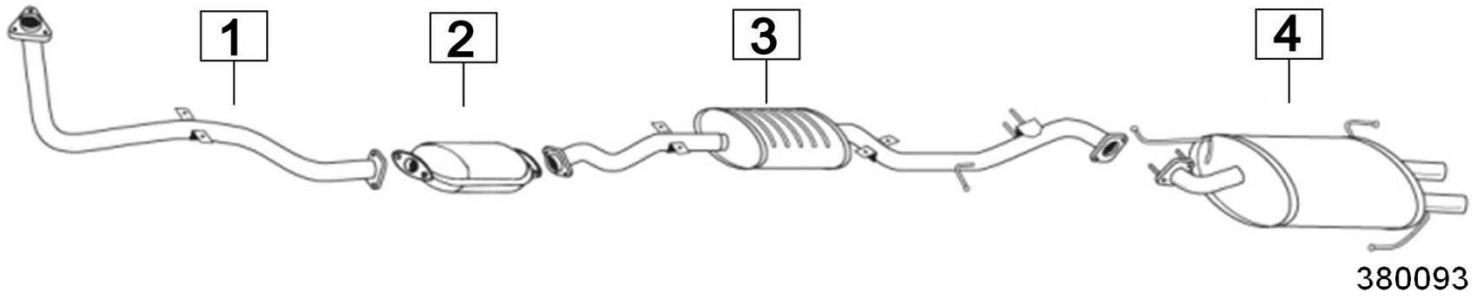

380093

	Codice	Descr.	O.E.	NOTE	Cod. Accessori
1	7534400	T C	2010082F02		A
2	7534412	KAT	2080082F25		B
3	7534406	M C	2030069F00 2030069F27 2030069F25		C
4	7534408	M P	2010083F00 2010083F25		D

NISSAN ALMERA 1400 / 1600 16V 1392-1597cc 64-73KW 95- 2/00

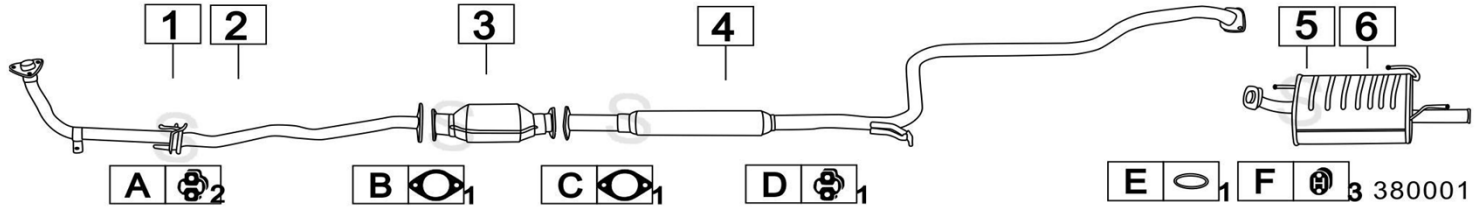

380001

	Codice	Descr.	O.E.	NOTE	Cod. Accessori
1	7121100	T C	200100N210	per 1400	A 2753903
2	7521130	T C	200100N200	per 1600	B 2750907
3	7521112	KAT	208001N325-2080070J25		C 2750907
4	7521106	M C	203000N210		D 2753903
5	7521107	M P	201000N060 - 201000N766	per 2 volumi	E 2791938
6	7521137	M P	201000N000	per 3 volumi	F 2753911

NISSAN ALMERA 2000 Gti 1998cc 105KW 7/96- 99

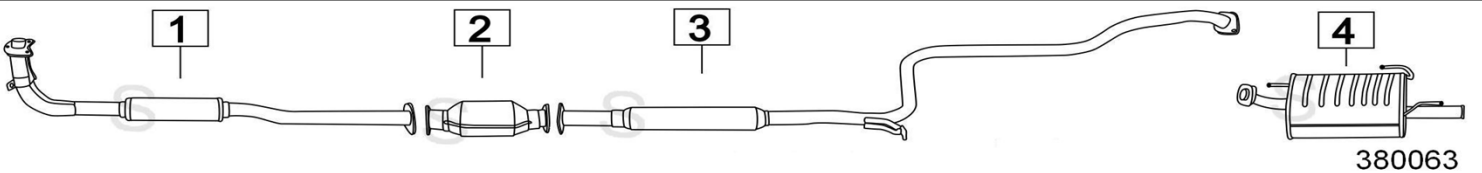

380063

	Codice	Descr.	O.E.	NOTE	Cod. Accessori
1	7521600	T C	200200N661		A
2	7507712	KAT	208021C726 - 208023J025 - 208023J325		B
3	7521606	M C	203000N660		C
4	7521607	M P	201000N663		D

NISSAN ALMERA 2000 DIESEL 1974cc 55KW 95- 2/00

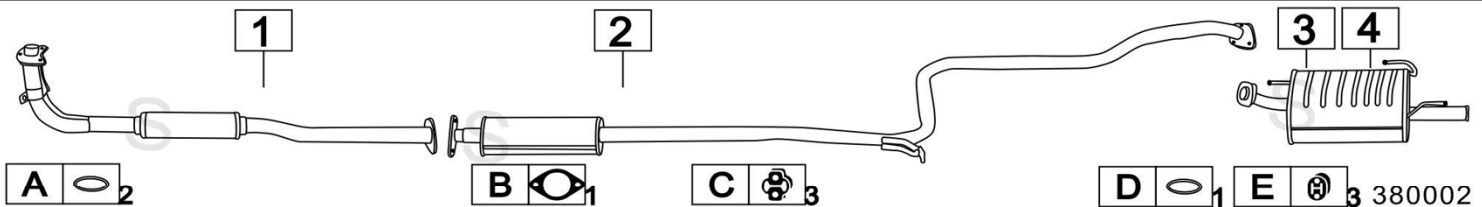

380002

	Codice	Descr.	O.E.	NOTE	Cod. Accessori
1	7500800	T C	200200N700		A 2791943
2	7500806	M C	203000N700		B 2750907
3	7521107	M P	201000N060 - 201000N766	per 2 volumi	C 2753903
4	7521137	M P	201000N000	per 3 volumi	D 2791938
5					E 2753911

NISSAN ALMERA II 1500/1800 16V 1497-1769cc 72-82KW 2/00- 8/02

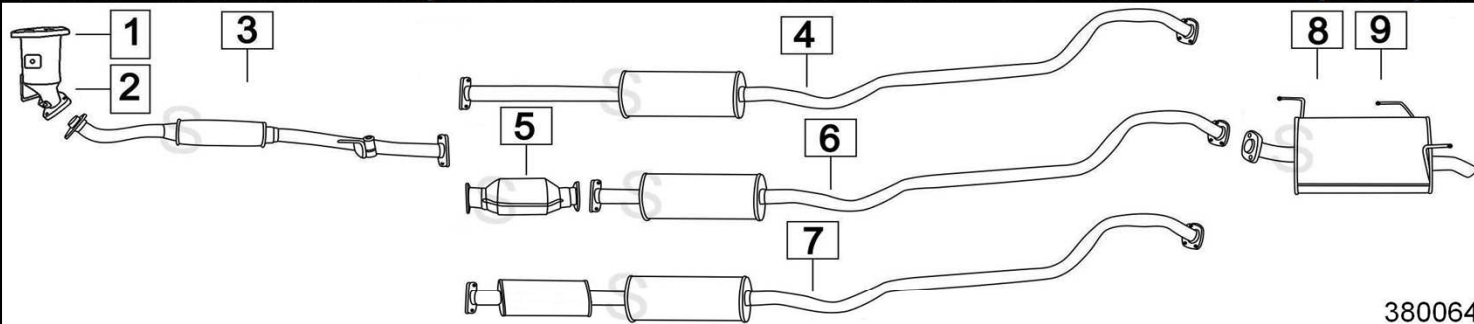

380064

	Codice	Descr.	O.E.	NOTE	Cod. Accessori
1	7532010	KAT	B08A0BM701		A
2	7532110	KAT	B08A0BM4010-B08A0BM711	dal 01/2001	B
3	7500300	T C	200105M370 - 200105M370KE		C
4	7532106	M C	20300BM500 - 20300BM500KE	per 1500 EURO3	D
5	7532112	KAT	208027J725-208023J325-208025M425	per 1500/1800 EURO4	E
6	7532206	M C	203005M370-203005M770	per 1500/1800 EURO4	F
7	7532146	M C	20300BM700-20300BN810	per 1800 EURO3	G
8	7532137	M P	20100BM505 - 20100BM500 - 20100BM505KE	per 2 volumi	H
9	7532107	M P	20100BM520	per 3 volumi	I

NISSAN ALMERA II 2200 TURBO DIESEL 2184cc 81KW 2/00- 2/03

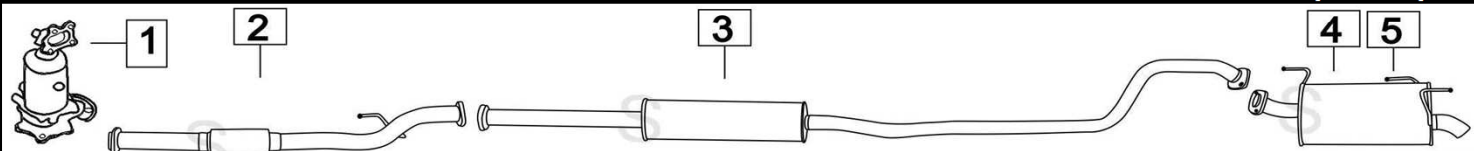

380067

	Codice	Descr.	O.E.	NOTE	Cod. Accessori
1	7500512	KAT	B08A05M302 - 208A08H825 - 208A08H827		A
2	7500505	T A	200105M570		B
3	7500506	M C	203005M700		C
4	7500547	M P	201005M561 - 201005M561KE	per 2 volumi	D
5	7500537	M P	20100AV600 - 20100AV600KE	per 3 volumi	E

NISSAN ALMERA III 1500/1800 16V 1497-1769cc 72-82KW 8/02- 06

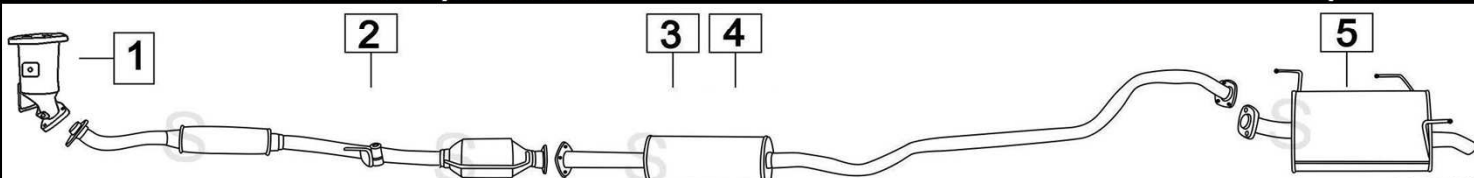

380065

	Codice	Descr.	O.E.	NOTE	Cod. Accessori
1	7532210	KAT	B08A0AU000		A
2	7532216	KAT	20100BN815		B
3	7532206	M C	203005M370	per 1500	C
4	7532146	M C	203005M770	per 1800	D
5	7532137	M P	20100BM505 - 20100BM500 - 20100BM505KE	per 2 volumi	E
6	7532107	M P	20100BM520	per 3 volumi	F

NISSAN ALMERA III 1500/1800 16V 1497-1769cc 72-82KW 8/02- 06

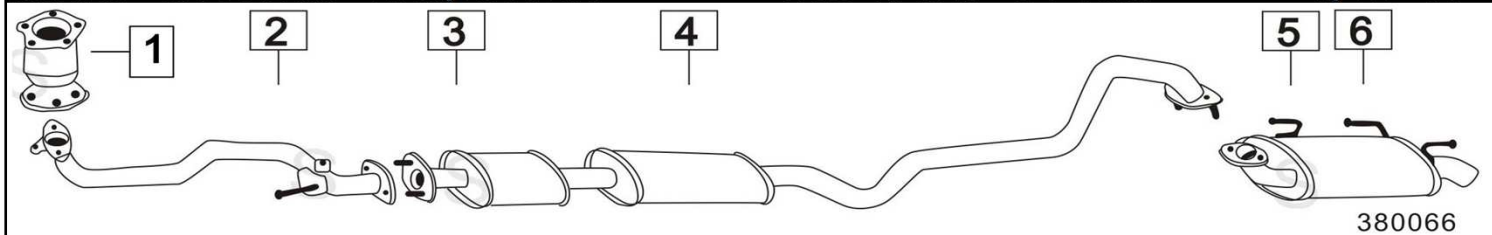

	Codice	Descr.	O.E.	NOTE	Cod. Accessori
1	7532210	KAT	B08A0AU000		A
2	7532200	T C	20010BN800 - 20010BN805		B
3	7532136	M C	20300BN800 - 20300BN800KE	per 1500	C
4	7532146	M C	20300BN810	per 1800	D
5	7532137	M P	20100BM505 - 20100BM500 - 20100BM505KE	per 2 volumi	E
6	7532107	M P	20100BM520	per 3 volumi	F

NISSAN ALMERA III 1500 Dci 1461cc 61KW 8/02- 06

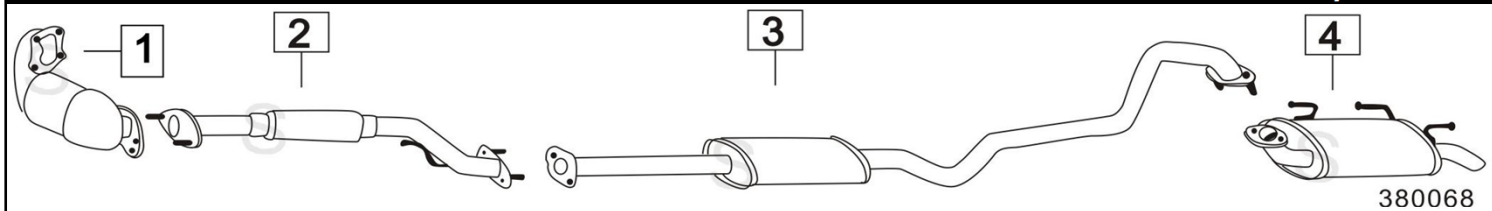

	Codice	Descr.	O.E.	NOTE	Cod. Accessori
1	7532910	KAT	208A0BN700		A
2	7532905	T A	20010BN700		B
3	7500506	M C	203005M700		C
4	7500537	M P	20100AV600 - 20100AV600KE	per 3 volumi	D

NISSAN ALMERA TINO 1800 16V 1769cc 82KW 5/00- 2/03

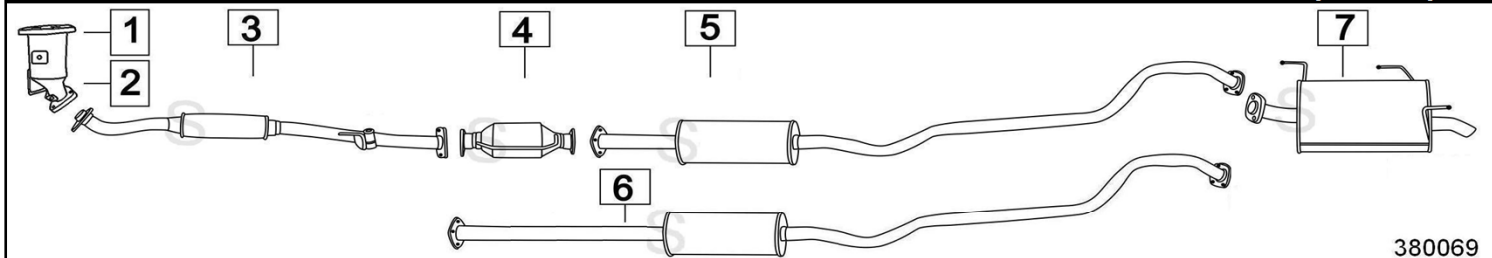

	Codice	Descr.	O.E.	NOTE	Cod. Accessori
1	7532010	KAT	B08A0BM701		A
2	7532110	KAT	B08A0BM401	dal 01/2001	B
3	7500330	T A	200104U340		C
4	7532112	KAT	208027J725		D
5	7500306	M C	20300BU315 - 20300BU311	con AIRPD L. 1770mm	E
6	7500336	M C	20300BU316	senza AIRPD L. 2080mm	F
7	7500307	M P	201004U310 - 201004U200		G

NISSAN ALMERA TINO 2000 16V 1998cc 100KW 5/00- 2/03

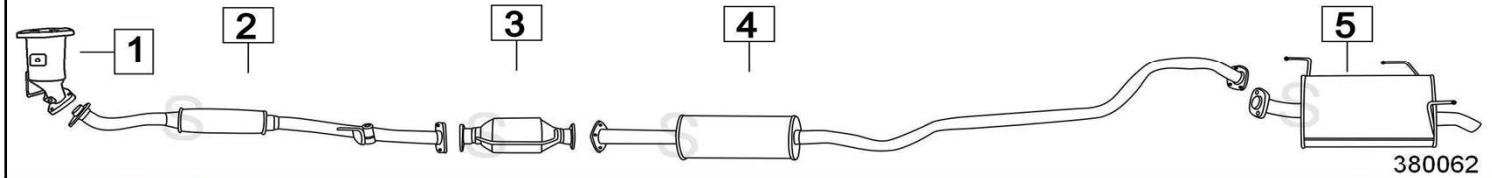

	Codice	Descr.	O.E.	NOTE	Cod. Accessori
1	7532710	KAT	206A07J510		A
2	7532700	T A	200104U250		B
3	7532716	KAT	208027J625		C
4	7532706	M C	20300BU200 - 20300BU210		D
5	7532707	M P	201004U200		E

NISSAN ALMERA TINO 2200 TURBO DIESEL 2184cc 81-84-100KW 2/00-

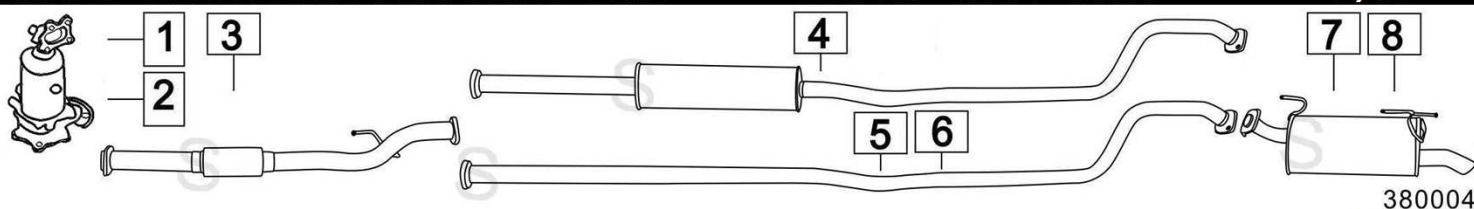

380004

	Codice	Descr.	O.E.	NOTE	Cod. Accessori
1	7500512	KAT	B08A05M302 - 208A08H825 - 208A08H827		A
2	7500510	KAT	206A0AU625	dal 02/2003	B
3	7500505	T I	200104U360		C
4	7532906	M C	20300BU365	fino al 08/2003	D
5	7532903	T I	20300BU366		E
6	7532933	T I	20300BU801	dal 02/2003	F
7	7532907	M P	201004U360		G
8	7532937	M P	20100BU800	dal 02/2003	H

NISSAN ALMERA TINO II 1800 16V 1769cc 85KW 2/03- 11/05

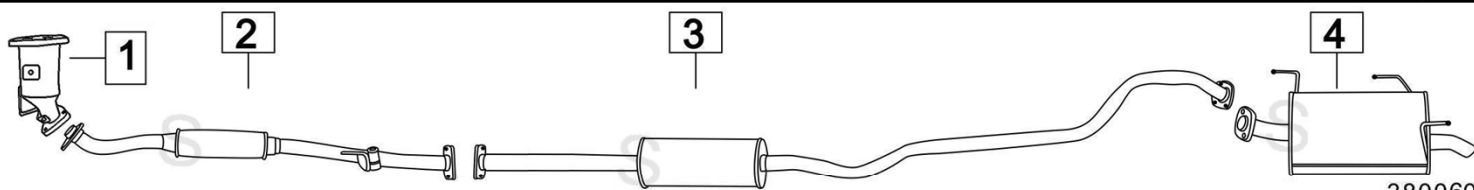

380060

	Codice	Descr.	O.E.	NOTE	Cod. Accessori
1	7532210	KAT	B08A0AU000		A
2	7532230	T A	20010BU705		B
3	7500336	M C	20300BU316	passo lungo L. 2080mm	C
4	7500307	M P	201004U310 - 201004U200		D

NISSAN ALMERA TINO II 1800 16V 1769cc 85KW 2/03- 11/05

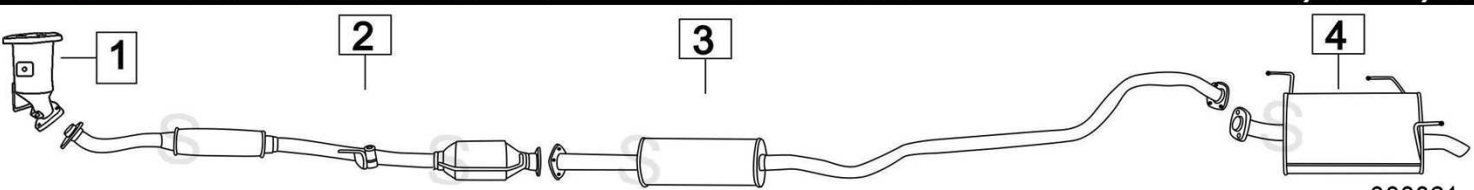

380061

	Codice	Descr.	O.E.	NOTE	Cod. Accessori
1	7532210	KAT	B08A0AU000		A
2	7500316	KAT	20010BU706		B
3	7500306	M C	20300BU315 - 20300BU311	passo corto L. 1770mm	C
4	7500307	M P	201004U310 - 201004U200		D

NISSAN BLUEBIRD 1600 - 1800 - 2000 1598/1809/1973cc 66/74/75KW 86- 90

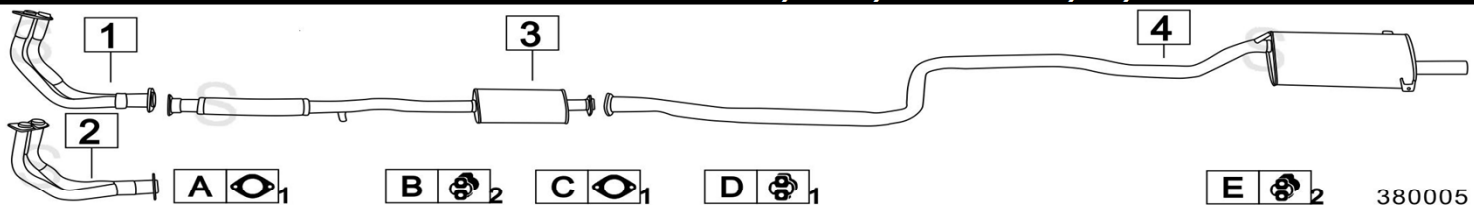

380005

	Codice	Descr.	O.E.	NOTE	Cod. Accessori
1	7500700	T C	2002011E00	per 1600 / 1800	AC 2750901
2	7500730	T C	20010D4600	per 2000	BE 2783910
3	7500706	M C	20020D4600-20020D5610-20020Q9015-20020Q9030KE		D 2753903
4	7500707	M P	20100D3605-20100Q9000		

NISSAN BLUEBIRD 1800 TURBO 1809cc 99KW 86- 90

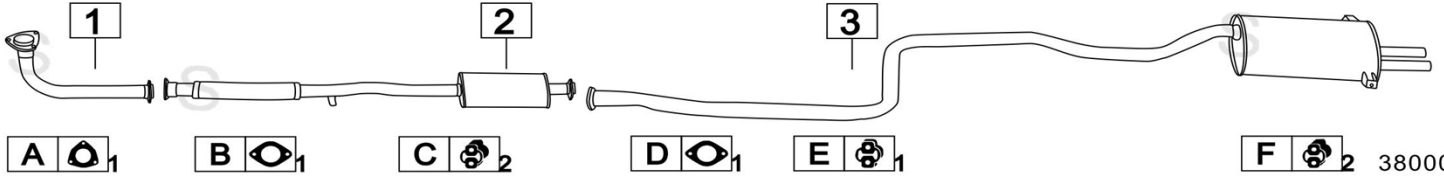

	Codice	Descr.	O.E.	NOTE	Cod. Accessori
1	7500400	T C	2001011E10		BD 2750901
2	7500706	M C	20020D4600-20020D5610-20020Q9015-20020Q9030KE		CF 2783910
3	7500407	M P	20100Q9005-20100Q9005KE		E 2753903

NISSAN BLUEBIRD 2000 COUPE' Mot:CA20E 1973cc 77KW 86- 88



	Codice	Descr.	O.E.	NOTE	Cod. Accessori
1	7500430	T C	20010D4520		A
2	7500405	T A	20020D4210		B
3	7541512	KAT	208020F307		C
4	7500437	M P	20100D4511		D

NISSAN BLUEBIRD 2000 DIESEL 1952cc 49KW 86- 90

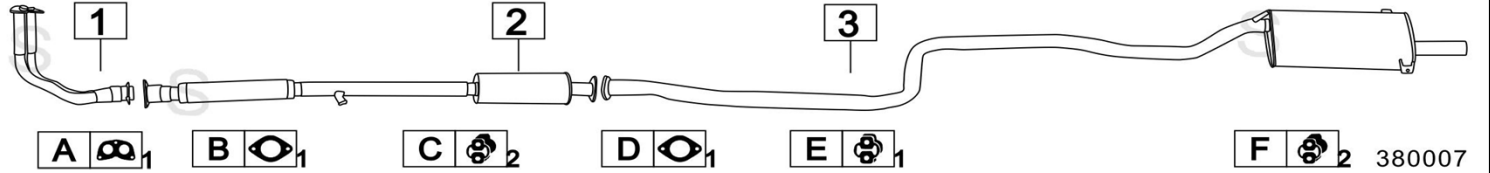

	Codice	Descr.	O.E.	NOTE	Cod. Accessori
1	7500900	T C	2002005E00		A 2750902
2	7500906	M C	20020Q9025KE		B 2750901
3	7500707	M P	20100D3605-20100Q9000		C 2783910

NISSAN CABSTAR 2500 DIESEL Mot:TD25 2494cc 55KW 89- 12/95

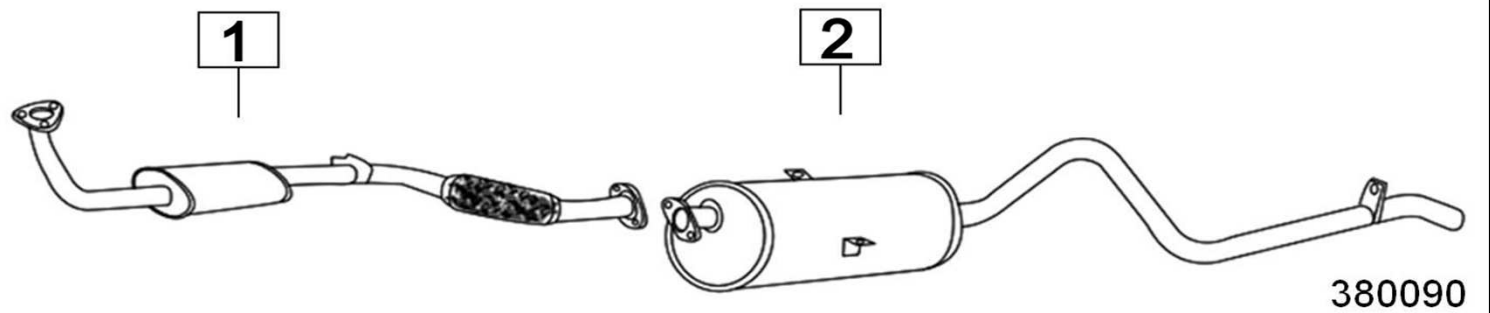

	Codice	Descr.	O.E.	NOTE	Cod. Accessori
1	7537232	M A	2001025T00		A
2	7537237	M P	2010010T00		B

NISSAN CABSTAR 120 3000 DIESEL Mot:BD30TI 12/00-

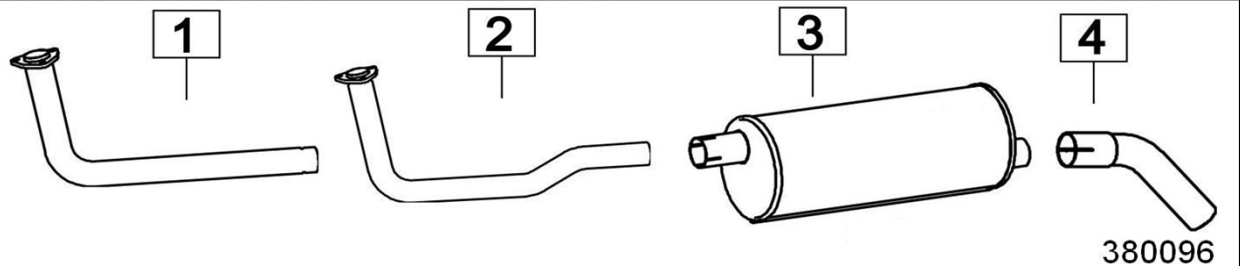

	Codice	Descr.	O.E.	NOTE	Cod. Accessori
1	7537200	T C	20010F3902		A
2	7537400	T C	200109X202 - 200109X200	dal 5/2001	B
3	7537506	M C	201009X200 - 20100D6200		A
4	7537504	T P	200409X100		B

NISSAN CABSTAR F24 2500/3000 TD Mot:YD25/ZD30 82-97-110KW 10/06-

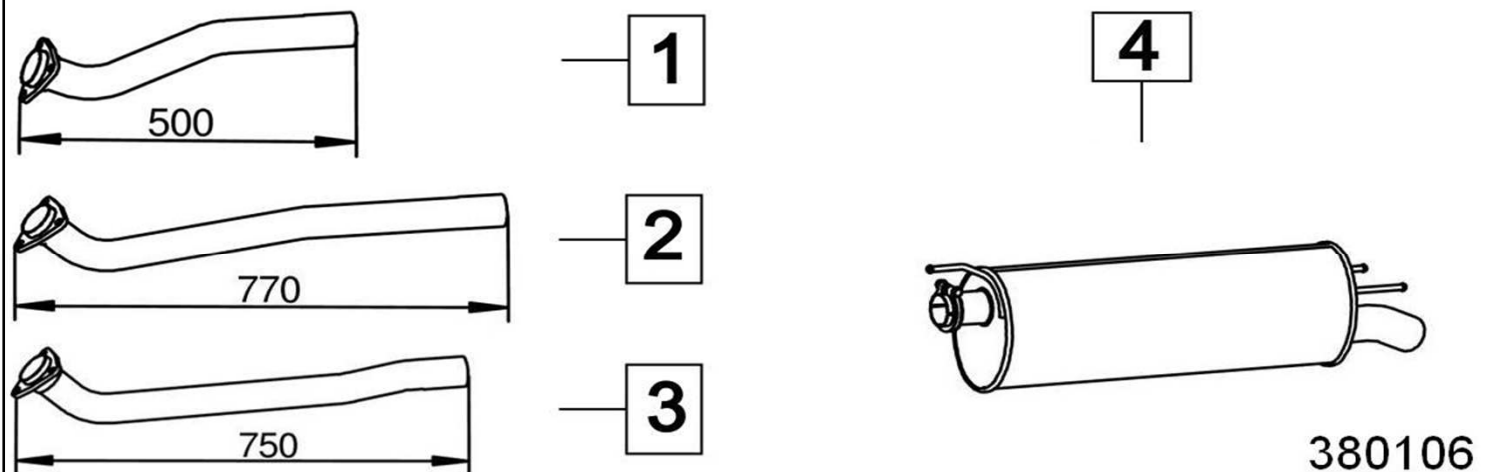

	Codice	Descr.	O.E.	NOTE	Cod. Accessori
1	7537430	T C	20020MB40A		A
2	7537440	T C	20020MA710		B
3	7537450	T C	20010LA20A		C
4	7537407	M P	20100MB40B		D

NISSAN INTERSTAR 1900/2200/2500/3000 DCI 60-66-73-84-100KW 7/02-

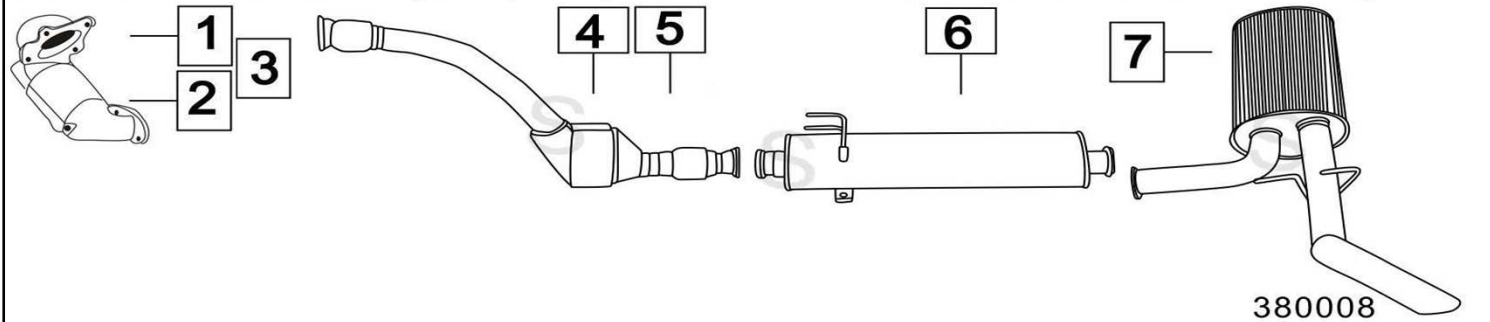

	Codice	Descr.	O.E.	NOTE	Cod. Accessori
1	6267310	KAT	8200125137	per 1900 flangia 3 fori	A
2	6267410	KAT	8200357277 - 4413983	per 2200 flangia 2 fori	B
3	6267510	KAT	8200153508	per 2500 flangia 2 fori	C
4	6267412	KAT	2001000QAJ	per 2200 / 2500 flangia 2 fori	D
5	6267312	KAT	8200205795 - 4501422	per 1900 flangia 3 fori	E
6	6267306	M C	2030000QAA		F
7	6267307	M P	2010000QOB		G

NISSAN JUKE 1500 DCi 2WD Mot. K9K EURO4 1461cc 81KW 06/10-

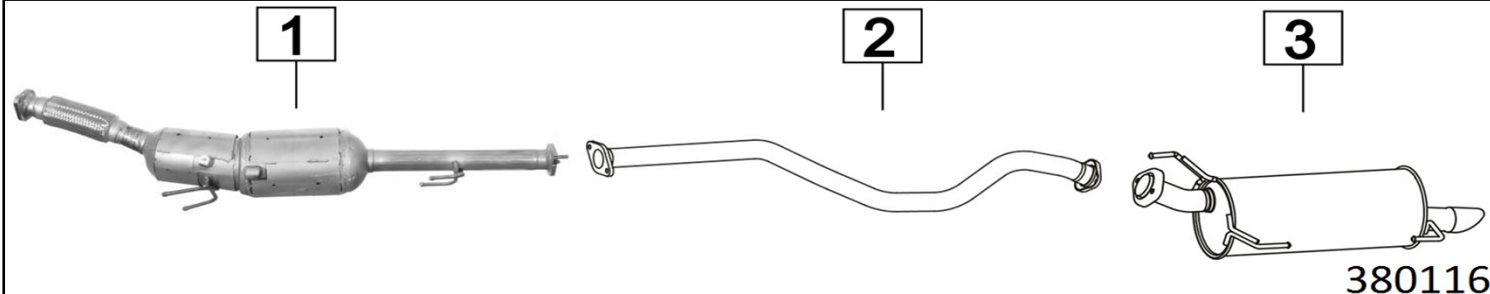

	Codice	Descr.	O.E.	NOTE	Cod. Accessori
1	7501922	FAP	200101KB0A		A
2	7501904	T I	203001KB0A		B
3	7501907	M P	201001KK0A 201001KK1A 201001KK0B		C

NISSAN KING CAB 2400 BENZINA 2300/2500/2700 DIESEL 9/85-

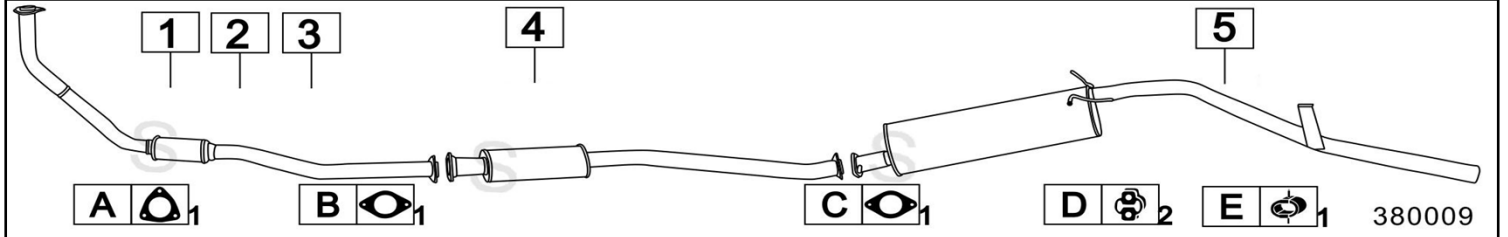

	Codice	Descr.	O.E.	NOTE	Cod. Accessori
1	7501730	T C	2002039G01 - 2002039G00 - 2002039G03	per benzina	A 2130924
2	7501740	T C	2001036G00	per diesel fino al 07/1987	B 2130930
3	7501700	T C	2001043G10	per diesel dal 08/1987	C 2130930
4	7501706	M C	2030038G00		D 2753903
5	7501707	M P	2010015G00-2010024G00KE		E 2753902

NISSAN KING CAB 2500 DIESEL CABINA DOPPIA 2494cc 59KW 4/92- 2/98

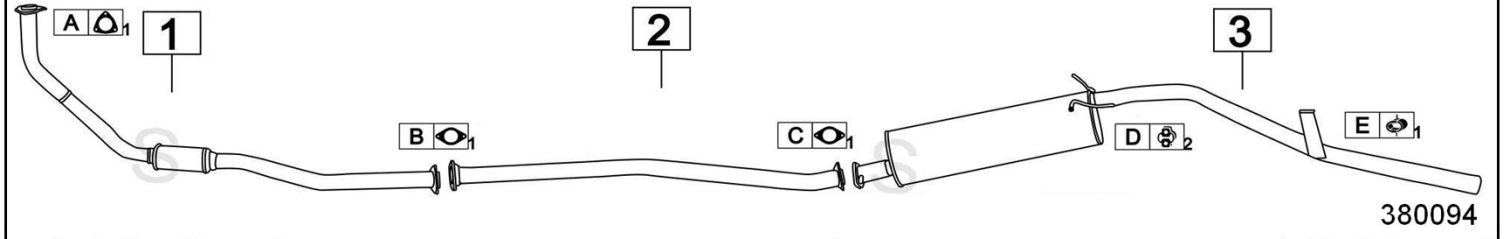

	Codice	Descr.	O.E.	NOTE	Cod. Accessori
1	7501700	T C	2001043G10		A
2	7529603	T I	2003038G17 2003038G10		B
3	7529607	M P	2010040G00 2010040G07		C

NISSAN KUBISTAR 1200i M:DTF726 1149cc 43KW 7/03-

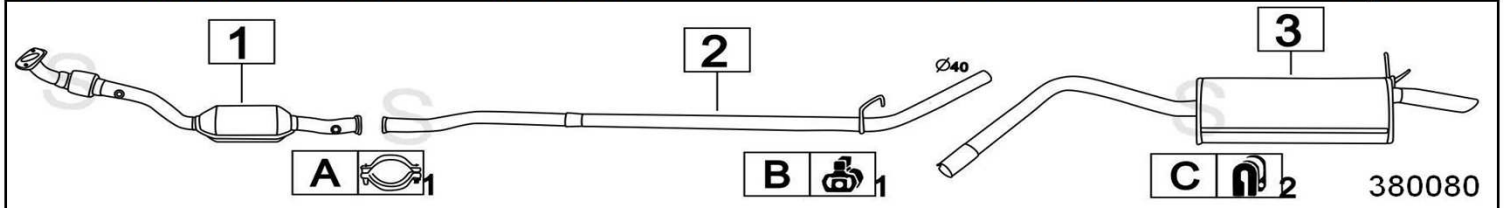

	Codice	Descr.	O.E.	NOTE	Cod. Accessori
1	6218812	KAT	7700847362-7700847363		A 2931901
2	6223003	T A	7700310431		B 2133914
3	6223007	M P	7700312439		C 2223915

NISSAN KUBISTAR 1200 16V M:D4F 1149cc 55KW 7/03-

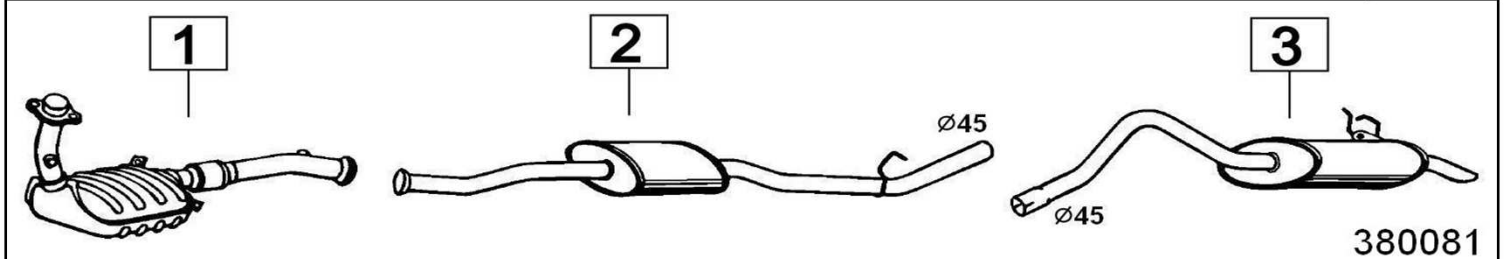

	Codice	Descr.	O.E.	NOTE	Cod. Accessori
1	6218812	KAT	8200122935		A
2	6246606	M C	8200063326		B
3	6223207	M P	8200063327		C

NISSAN KUBISTAR 1500 dCi M:K9K 1461cc 44-48-59KW 7/03-

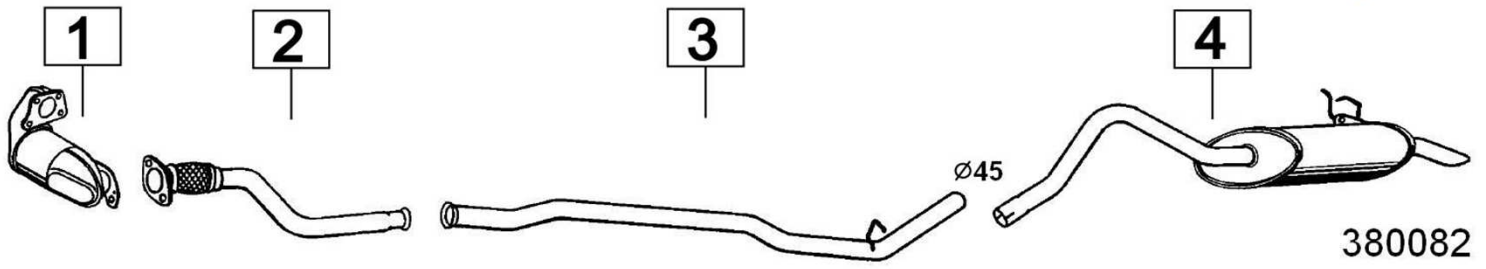

380082

	Codice	Descr.	O.E.	NOTE	Cod. Accessori
1	7532910	KAT	208A0BN700 - 208A0BN701		A
2	6218805	T A	8200063326		B
3	6247206	T I	8200075853		C
4	6223207	M P	8200261265		D

NISSAN MAXIMA 2000/3000 QX Mot.VQ20DE/30DE 1995-2998cc 103-142KW 10/94- 12/99

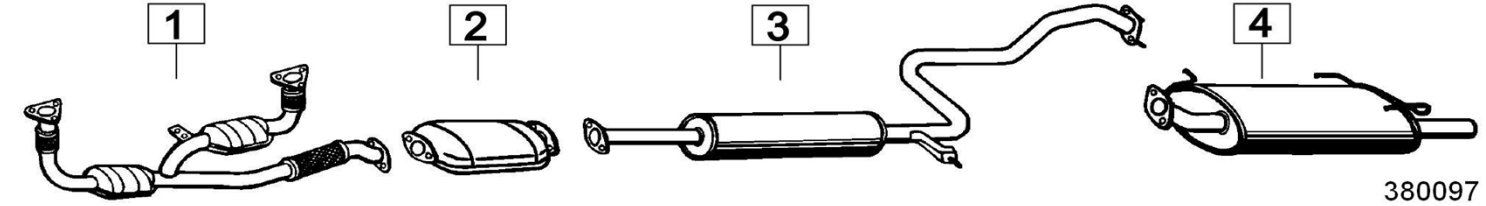

380097

	Codice	Descr.	O.E.	NOTE	Cod. Accessori
1	7525410	KAT	140124U21	solo cambio manuale	A
2	7525412	KAT	2080075C25		B
3	7525406	M C	2030040U00 - 2030041U00		C
4	7525407	M P	2010038U15 - 2010038U27		D

NISSAN MAXIMA 2000/3000 QX Mot.VQ20DE/30DE 1995-2998cc 103-147KW 1/00-

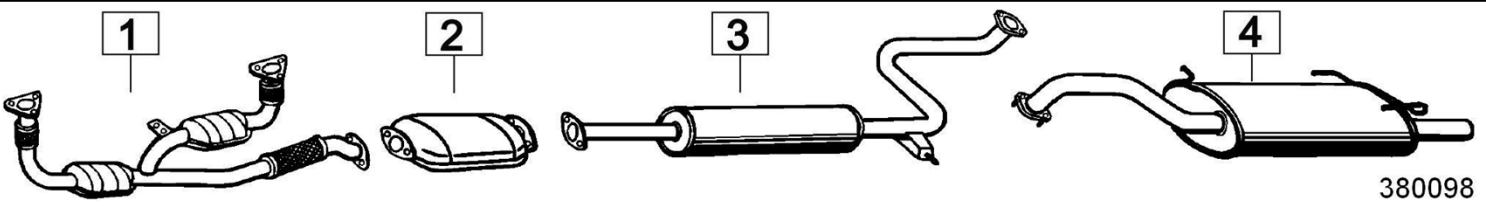

380098

	Codice	Descr.	O.E.	NOTE	Cod. Accessori
1	7525410	KAT	140124U21	solo cambio manuale	A
2	7525416	KAT			B
3	7525436	M C	203004Y300		C
4	7525437	M P	201004Y300		D

NISSAN MICRA 1000 / 1200 83- 92

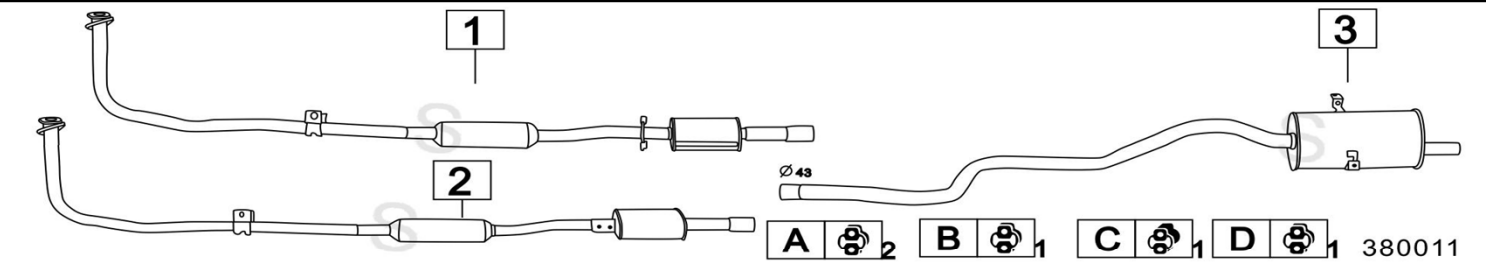

380011

	Codice	Descr.	O.E.	NOTE	Cod. Accessori
1	7505732	M A	2001031B00-2001031B03KE	dal 11/1988	AB 2753903
2	7505702	M A	2001015B00KE-2001015B05KE		C 2783910
3	7505707	M P	2010015B00-2010015B01KE-2010015B11-2010030B01KE		D 2753903

NISSAN MICRA 1200 CATALIZZATA 1235cc 7/86- 92

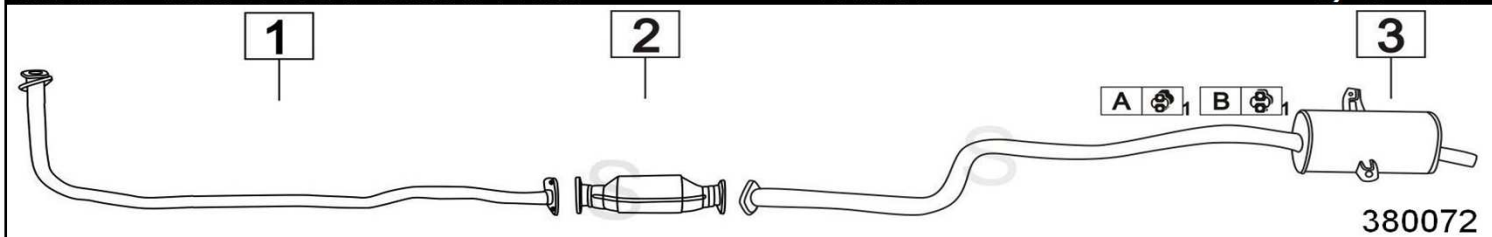

380072

	Codice	Descr.	O.E.	NOTE	Cod. Accessori
1	7505700	T C			A 2783910
2	7505716	KAT			B 2753903
3	7505737	M P	B010M18B06CA		C

NISSAN MICRA 1000 / 1300 16V 998-1275cc 40-55KW 11/92-

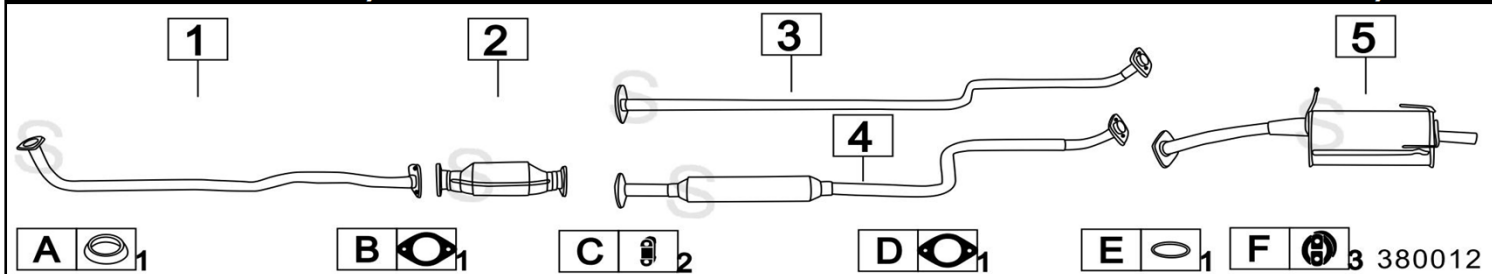

380012

	Codice	Descr.	O.E.	NOTE	Cod. Accessori
1	7505400	T C	2001099B00-2001099B00KE		A 2121945
2	7521112	KAT	B080099B00		BD 2750907
3	7505403	T A	2003099B00-2003099B02KE-B003M99B0MGA	per 1000	C 2753906
4	7505406	M C	2030099B01-B030M99B0AGA	per 1300	E 2791938
5	7505407	M P	201009B01-B010M99B01CB		F 2713903

NISSAN MICRA 1000 / 1400 16V 998-1348cc 44-60KW 8/00-

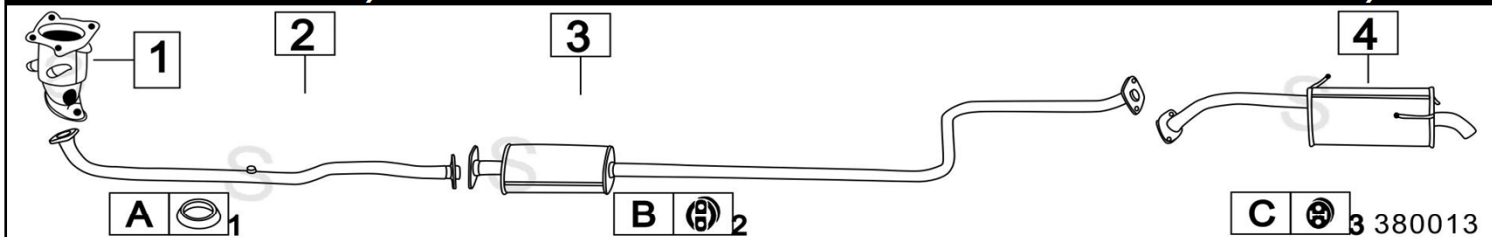

380013

	Codice	Descr.	O.E.	NOTE	Cod. Accessori
1	7505910	KAT			A 2231946
2	7505900	T C	200101F500KE		B 2713903
3	7505906	M C	203001F500KE		C 2323901
4	7505907	M P	201001F501KE - 201001F601KE		D

NISSAN MICRA 1000 / 1200 / 1400 16V 998-1240-1386cc 48-59-65KW 1/03- 4/05

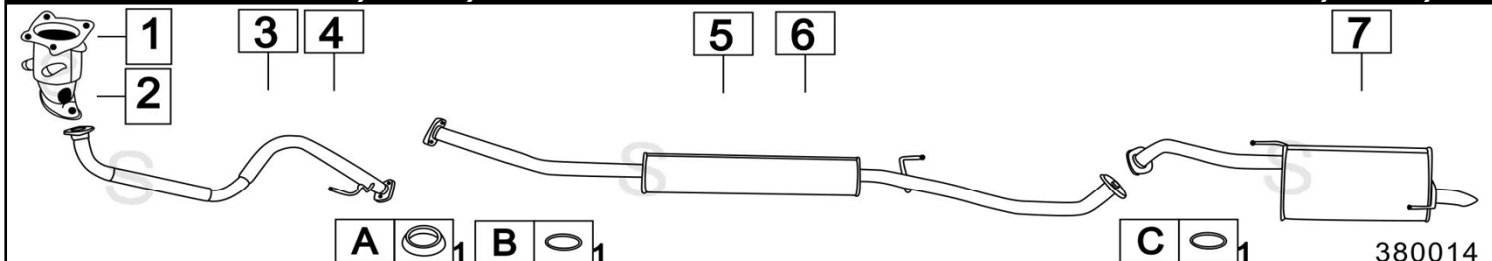

380014

	Codice	Descr.	O.E.	NOTE	Cod. Accessori
1	7505110	KAT	B08A0BX000	fino al 11/2003	A 2781943
2	7505210	KAT	206A0BX001	dal 11/2003	B 2791938
3	7505130	T C	20010AX600	fino al 11/2003	C 2791938
4	7505100	T C	20010AX60A	dal 11/2003	D
5	7505106	M C	20300AY100	fino al 11/2003	E
6	7505136	M C	20300AY110	dal 11/2003	F
7	7505107	M P	20100AY100		G

NISSAN MICRA 1000 / 1200 / 1400 16V 998-1240-1386cc 48-59-65KW 4/05-

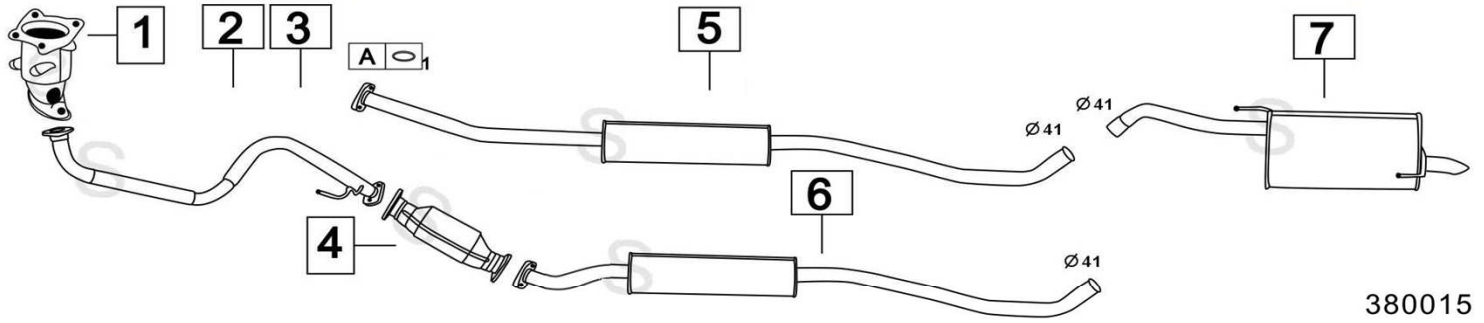

380015

	Codice	Descr.	O.E.	NOTE	Cod. Accessori
1	7505310	KAT	208A0BX00A		A 2791938
2	7505100	T C	20010AX60A		B
3	7505130	T C	20010AX600	per cambio automatico	C
4	7505712	KAT	20100AY10B	per cambio automatico	D
5	7505146	M C	20300AY11D		E
6	7505756	M C	20300AY11D	per cambio automatico	F
7	7505147	M P	20100AY10B		G

NISSAN MICRA 1500 dCi TURBO DIESEL 1461cc 48KW 1/03- 4/05

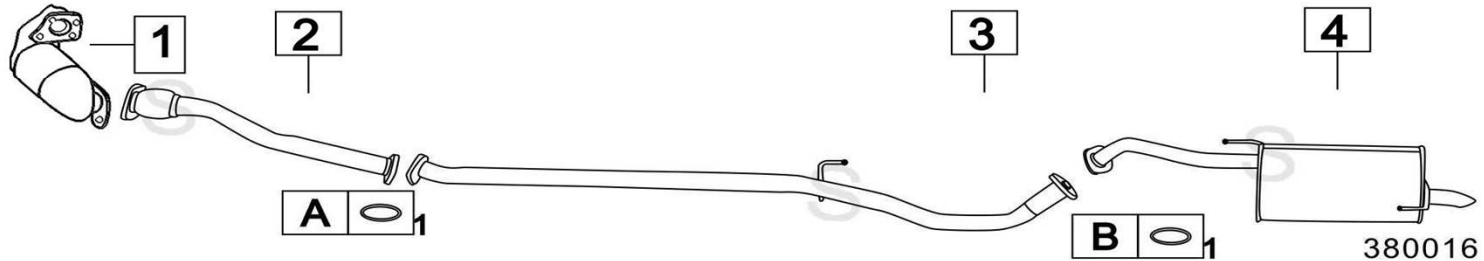

380016

	Codice	Descr.	O.E.	NOTE	Cod. Accessori
1	7532910	KAT	208A0BN700 - 208A0BN701		A 2791943
2	7520405	T A	20010AY600		B 2791938
3	7520403	T I	20300AY610		C
4	7505107	M P	20100AY100		D

NISSAN MICRA 1500 dCi TURBO DIESEL 1461cc 48KW 4/05-

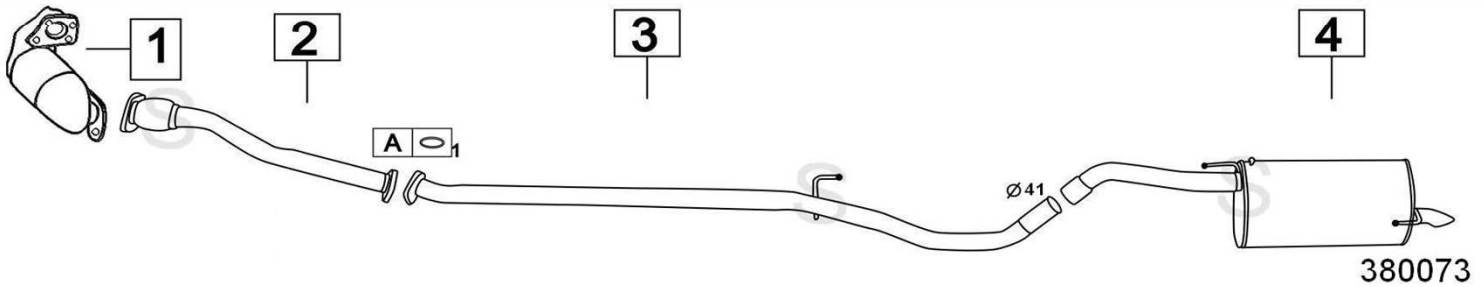

380073

	Codice	Descr.	O.E.	NOTE	Cod. Accessori
1	7532910	KAT	208A0BN700 - 208A0BN701		A 2791943
2	7520405	T A	20010AY600		B
3	7520443	T I	20300AY60A		C
4	7505147	M P	20100AY10B		D

NISSAN MICRA 1500 dCi TURBO DIESEL 1461cc 60KW 8/03- 4/05

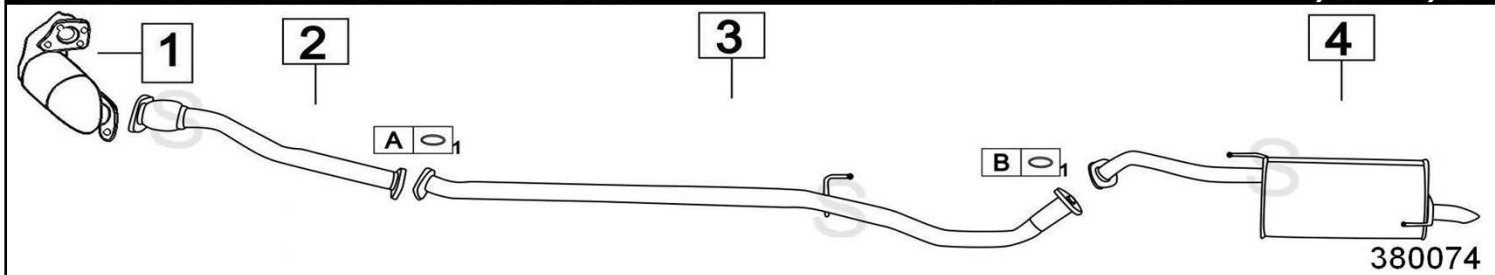

380074

	Codice	Descr.	O.E.	NOTE	Cod. Accessori
1	7532910	KAT	208A0BN700 - 208A0BN701		A 2791943
2	7520405	T A	20010AY600		B
3	7505103	T I			C
4	7505157	M P			D

NISSAN MICRA 1500 dCi TURBO DIESEL 1461cc 50-60-63KW 4/05-

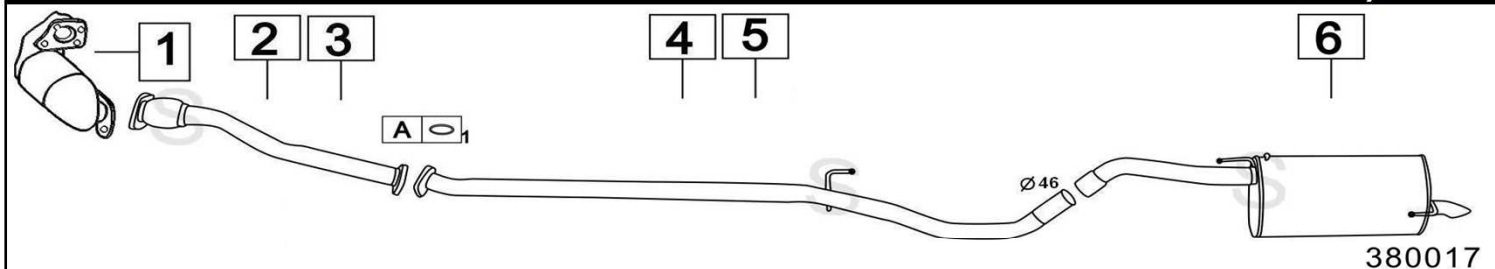

380017

	Codice	Descr.	O.E.	NOTE	Cod. Accessori
1	7532910	KAT	208A0BN700 - 208A0BN701		A 2791943
2	7520405	T A	20010AY600		B
3	7505105	T A	20010BC501	dal 10/2005 50/63KW	C
4	7520433	T I	20300AY61A		D
5	7505133	T I	20300BC50B	dal 10/2005 50/63KW	E
6	7505137	M P	20100AY11A		F

NISSAN MICRA IV 1200 Mot:HR12DE-HR12DDR 1198cc 59-72KW 05/10-

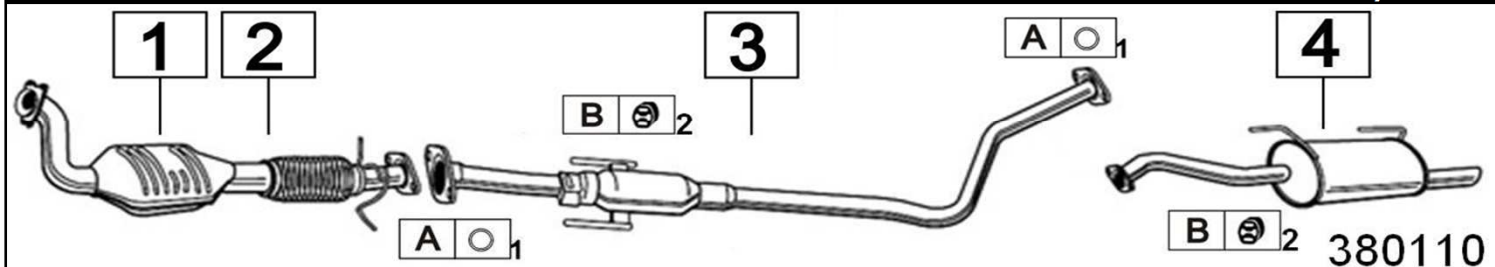

380110

	Codice	Descr.	O.E.	NOTE	Cod. Accessori
1	7502112	KAT	200101HA2B		A 2791938
2	7502212	KAT	200101HA2C	Dal 09/2010	B 2750907
3	7502206	M C	203001HA2A		C
4	7502207	M P	201001HD2A		D

NISSAN MURANO 3500 V6 24V 4WD MOT:VQ35DE 3498cc 172KW 05- 1/08

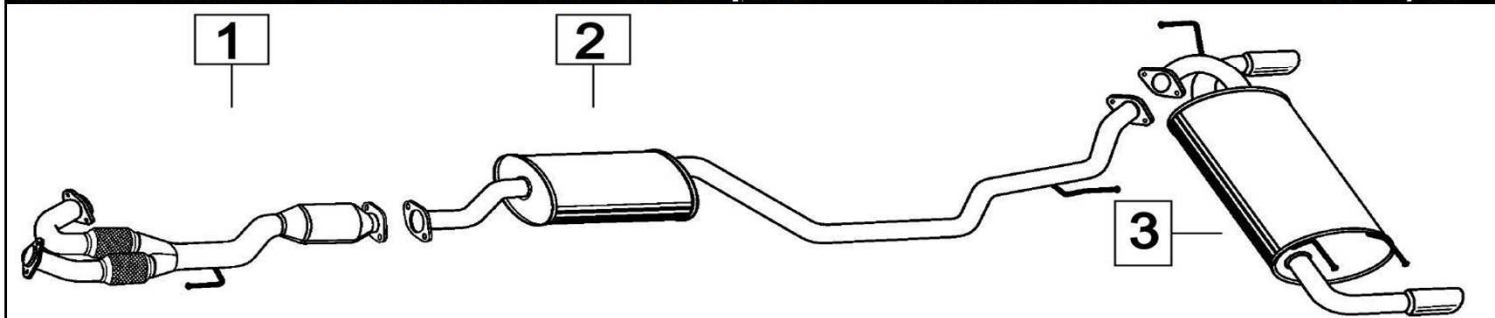

380083

	Codice	Descr.	O.E.	NOTE	Cod. Accessori
1	7537712	KAT	B08A2CB000		A
2	7537706	M C	20300CC00B		B
3	7537707	M P	20100CC00A		C

NISSAN NAVARA PICK UP TURBO DIESEL 4WD 2494-2488cc 76-98KW 98-

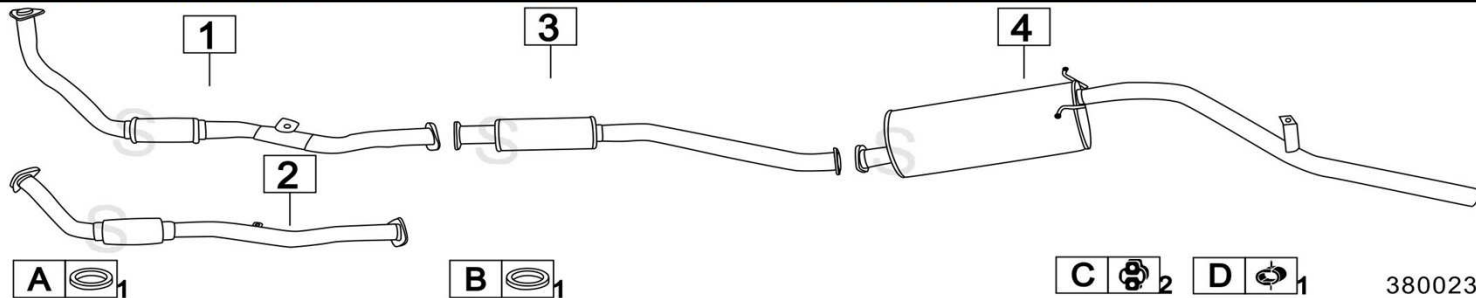

Codice	Descr.	O.E.	NOTE	Cod. Accessori
1	7501400 T C	200103S300	per 76KW	A 2771950
2	7501430 T C	20010VK510	per 98KW catalizzata	B 2771950
3	7501406 M C	20300VK500		C 2753903
4	7501407 M P	20100VK101		D 2753902

NISSAN NAVARA 2500 TURBO DIESEL 2488cc 106-126-128KW 5/05-

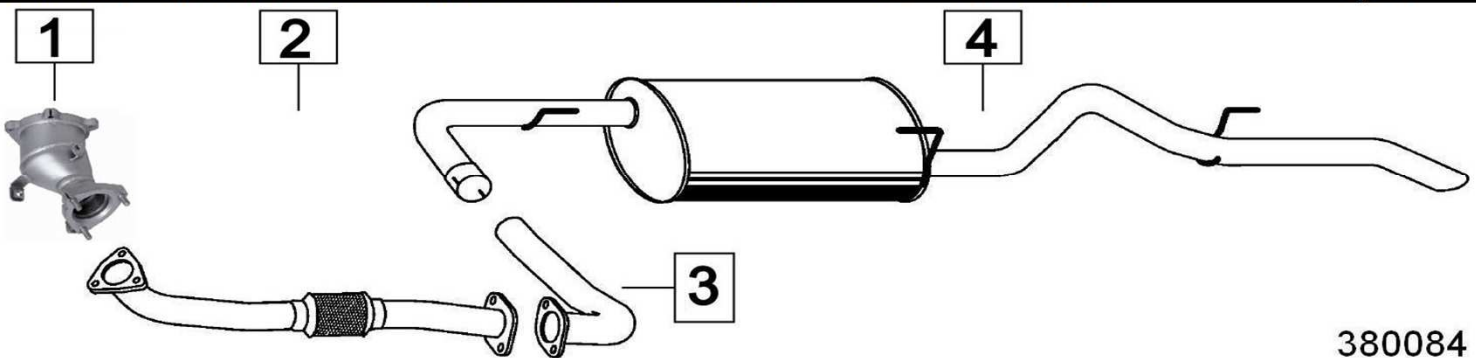

Codice	Descr.	O.E.	NOTE	Cod. Accessori
1	7537810 KAT	208A0EB325		A
2	7537800 T C	20020EB30A		B
3	7537805 T A	20030EB300		C
4	7537807 M P	B0100EB31A B0100EB31B		D

NISSAN NOTE 1400 16V M:CR14DE 1386cc 65KW 3/06- 4/09

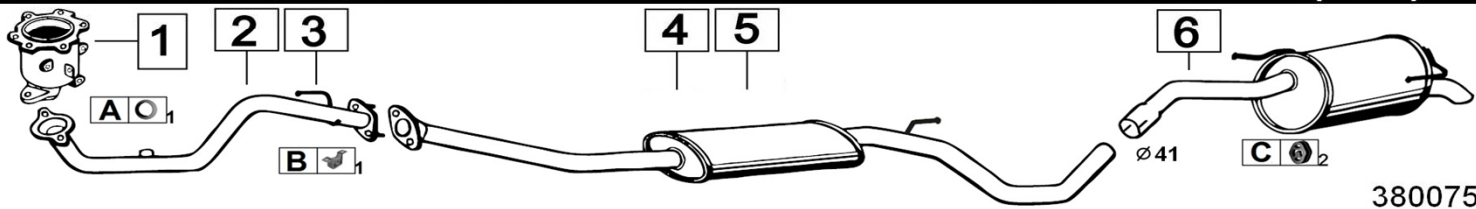

Codice	Descr.	O.E.	NOTE	Cod. Accessori
1	7505310 KAT	208A0BX00A - 208A0BX001		A 2231946
2	7505130 T C	203001U61A	Dal 03/2006 al 10/2007	B 2753927
3	7505100 T C	20010AX605	Dal 11/2007 al 04/2009	C 2753915
4	7505156 M C	203001U61A	Da 03/2006 al 10/2007	D
5	7505166 M C	203009U24A	Da 11/2007 al 04/2009	E
6	7505147 M P	20100AY10B		F

NISSAN NOTE 1400 16V M:CR14DE 1386cc 65KW 5/09-

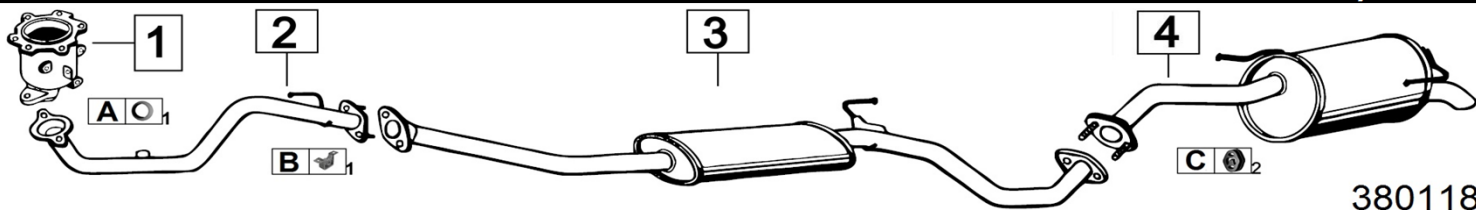

Codice	Descr.	O.E.	NOTE	Cod. Accessori
1	7505310 KAT	208A0BX00A - 208A0BX001		A 2231946
2	7505100 T C	20010AX605		B 2753927
3	7505006 M C	20300BH61C		C 2753915
4	7505107 M P	20100AY100		D

NISSAN NOTE 1600 16V M:HR16DE 1598cc 81KW 1/06-

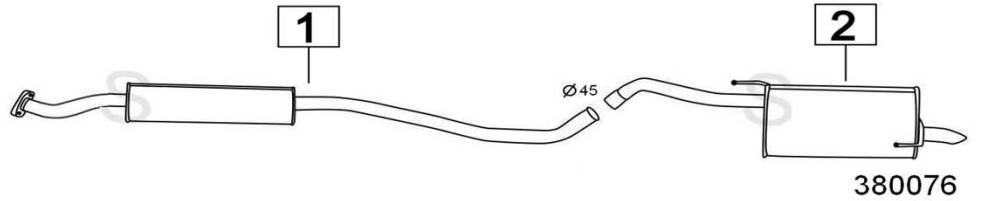

380076

	Codice	Descr.	O.E.	NOTE	Cod. Accessori
1	7505506	M C	203009U00A		A
2	7505507	M P	203009U00B		B

NISSAN NOTE 1600 16V M:HR16DE Euro5 1598cc 81KW 4/09-

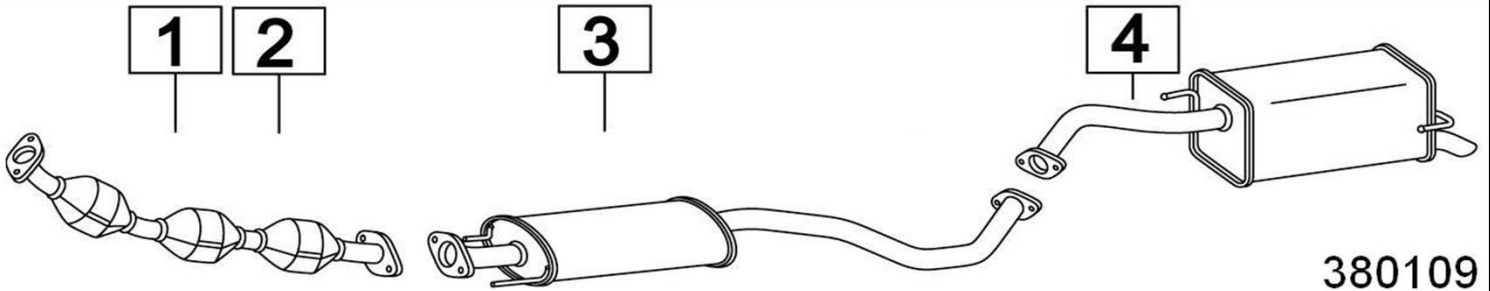

380109

	Codice	Descr.	O.E.	NOTE	Cod. Accessori
1	7505512	KAT	200109U21A		A
2	7505412	KAT	200109U22A	per cambio automatico	B
3	7505546	M C	20300BH60B		C
4	7505547	M P	20100BH60B		D

NISSAN NOTE 1500 dCi TURBO DIESEL M:K9K 1461cc 63KW 3/06-

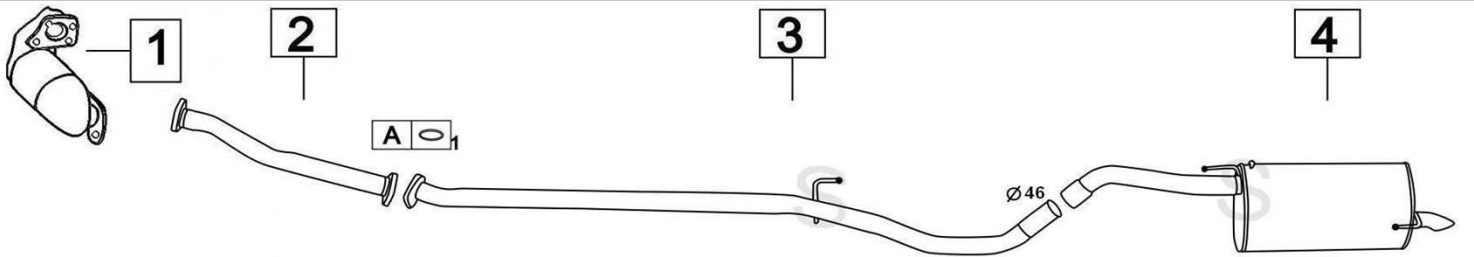

380077

	Codice	Descr.	O.E.	NOTE	Cod. Accessori
1	7505510	T C	1557600QAE		A
2	7505503	M C	20010BC501		B
3	7505536	M P	203009U2DA 203009U20A		C
4	7505137	M P	20100AY11B		D

NISSAN PATHFINDER 2500 TD 4WD M:YD25DDTi 2488cc 126-128KW 3/05-

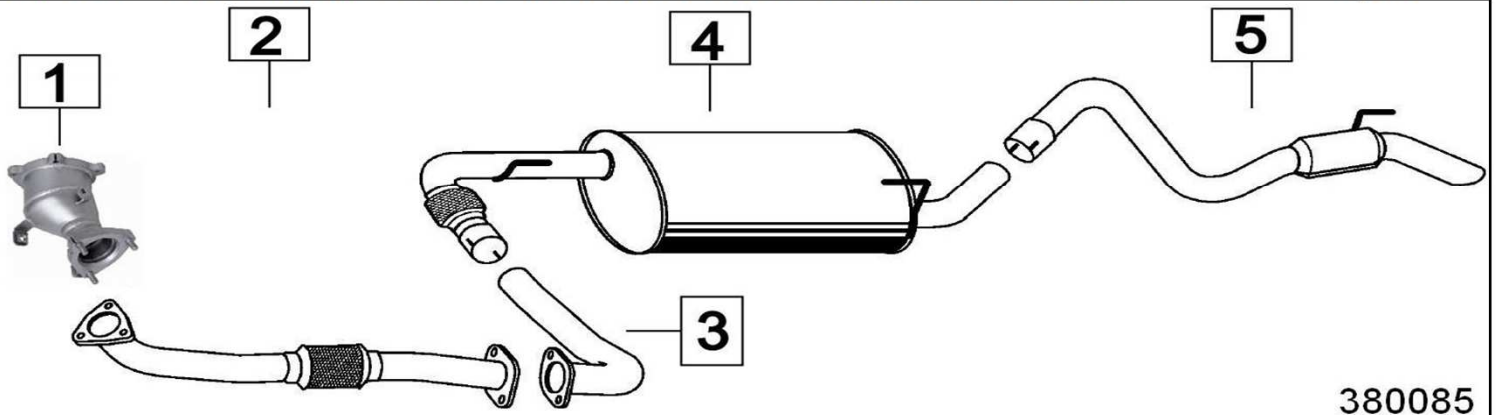

380085

	Codice	Descr.	O.E.	NOTE	Cod. Accessori
1	7537810	KAT	208A0EB325		A
2	7537800	T C	20020EB30A		B
3	7537805	T A	20030EB300		C
4	7537806	M C	20100EB3BB		D
5	7537837	M P	20050EB300		E

NISSAN PATHFINDER 2500 Dci DPF 4WD M:YD25DDTi 2488cc 130KW 09/06-

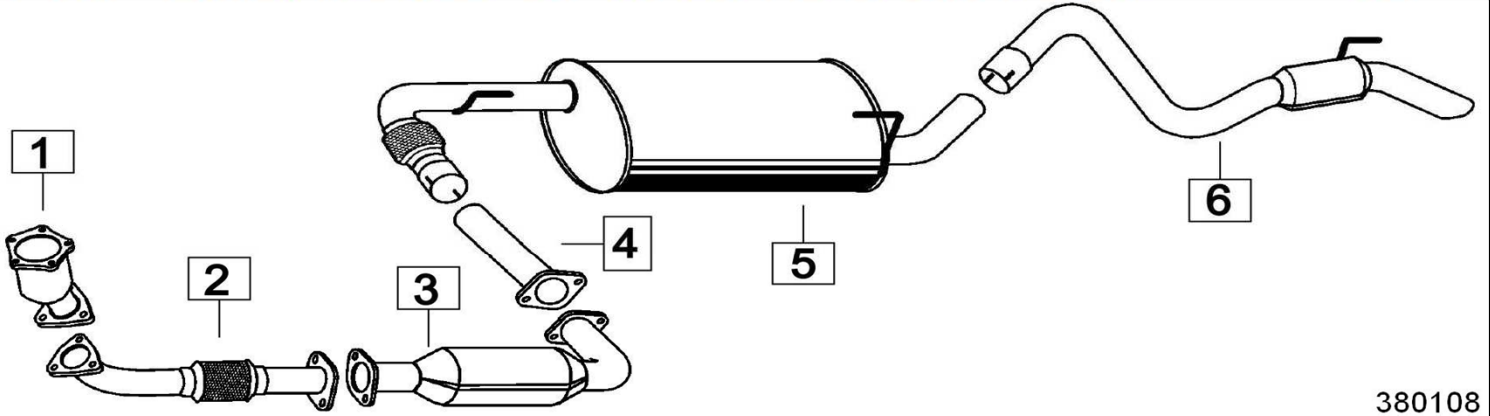

380108

	Codice	Descr.	O.E.	NOTE	Cod. Accessori
1	7537812	KAT	208A0EC00F		A
2	7537830	T C	B00203X01A		B
3	7537822	FAP	B0802EC00A		C
4	7537804	T I	B00303X00A		D
5	7537806	M C	20100EB3BB		E
6	7537837	M P	20050EB300		E

NISSAN PATROL 2800 BENZINA / 3200 DIESEL + TURBO DIESEL 82-

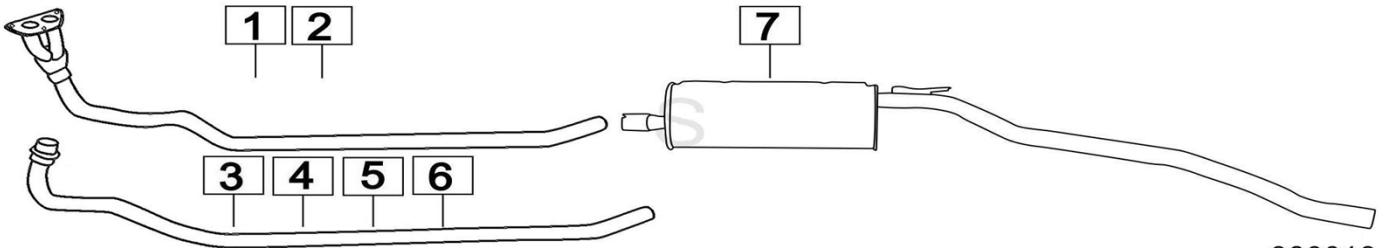

380018

	Codice	Descr.	O.E.	NOTE	Cod. Accessori
1	7518700	T C	20020C6601	per 2800 benzina 2 porte	A
2	7528500	T C	20020C6401	per 2800 benzina 4 porte	B
3	7518740	T C	20010C6100 - 20010C6100KE	per 3200 diesel 2 porte	C
4	7518750	T C	20010C6300 - 20010C6300KE	per 3200 diesel 4 porte	D
5	7518760	T C	20010C8200	per 3200 Turbo diesel 2 porte	E
6	7518770	T C	20010C8210	per 3200 Turbo diesel 4 porte	F
7	7518707	M P	20100C6800KE		G

NISSAN PATROL 2800 DIESEL 4X4 Mot:RD28 2826cc 68KW 4/89- 6/93

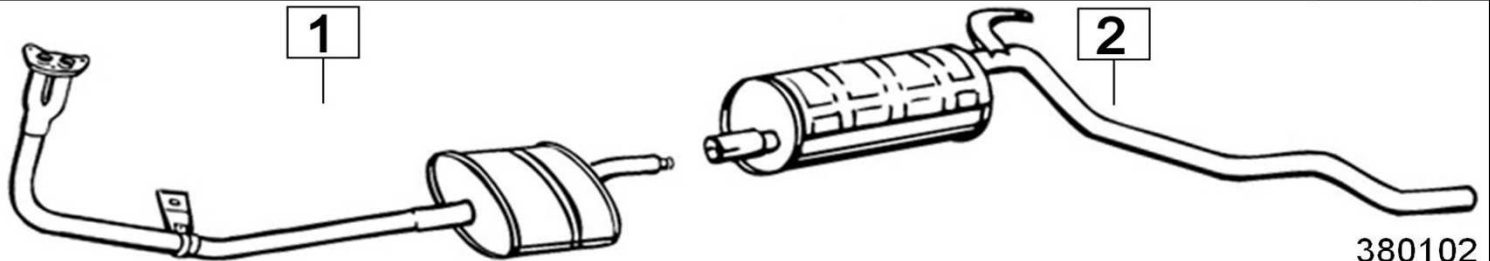

380102

	Codice	Descr.	O.E.	NOTE	Cod. Accessori
1	7528202	M A	20010G9801 - 20010G9805		A
2	7528207	M P	20100C7000 - 20100C7000KE		B

NISSAN PATROL GR 2800 TURBO DIESEL 2826cc 85KW 88- 10/91

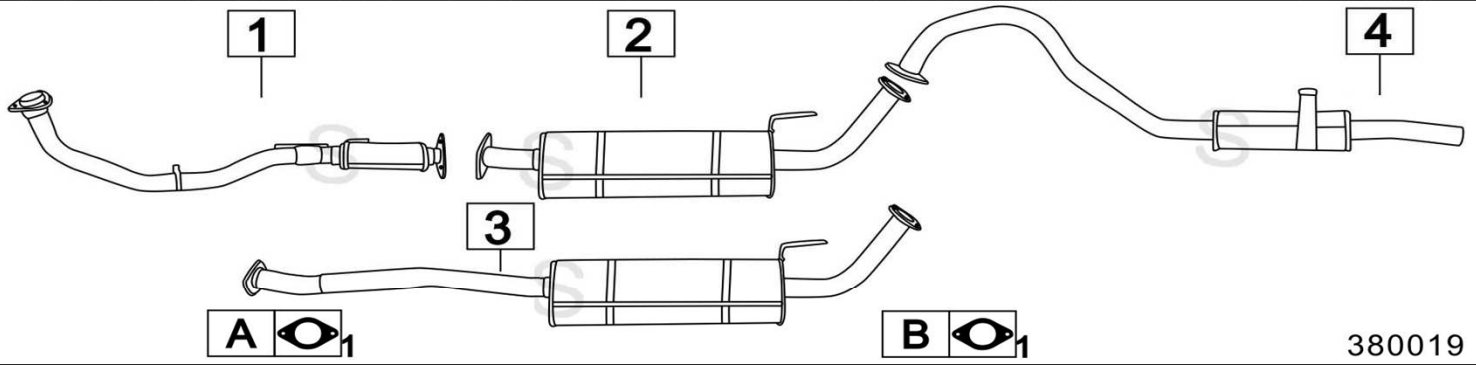

380019

	Codice	Descr.	O.E.	NOTE	Cod. Accessori
1	7515700	T C	2001034J00		A 2130930
2	7515706	M C	2010022J01	per 3 porte	B 2130930
3	7528706	M C	2010022J22 - 2010020J11	per 5 porte	C
4	7515707	M P	2035020J02		D

NISSAN PATROL GR 2800 TURBO DIESEL 2826cc 85KW 10/91- 4/96

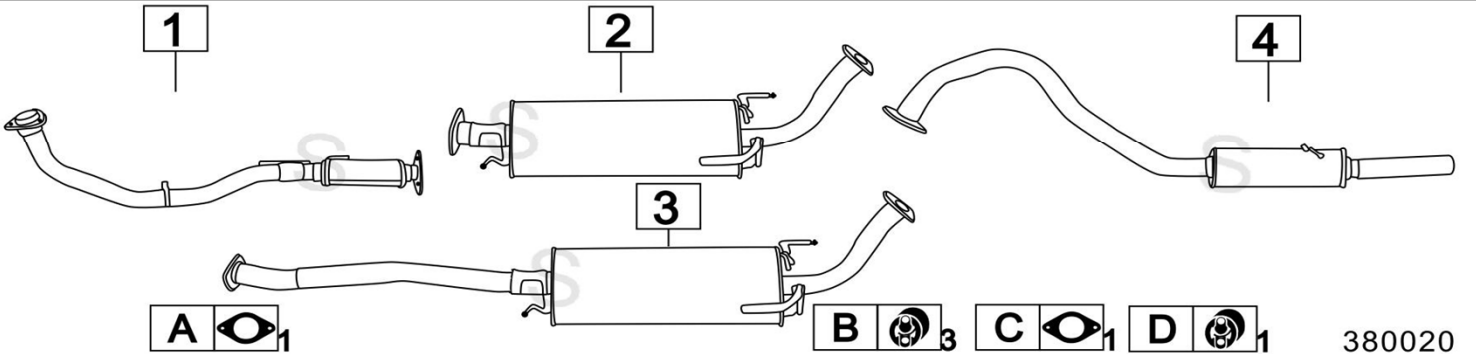

380020

	Codice	Descr.	O.E.	NOTE	Cod. Accessori
1	7515700	T C	2001034J00		A 2130930
2	7515746	M C	2010034J15	per 3 porte	B 2333922
3	7515756	M C	2010034J70	per 5 porte	C 2130930
4	7515737	M P	2035032J25-2035032J27		D 2333922

NISSAN PATROL GR 2800 TURBO DIESEL 2826cc 95KW 6/97-

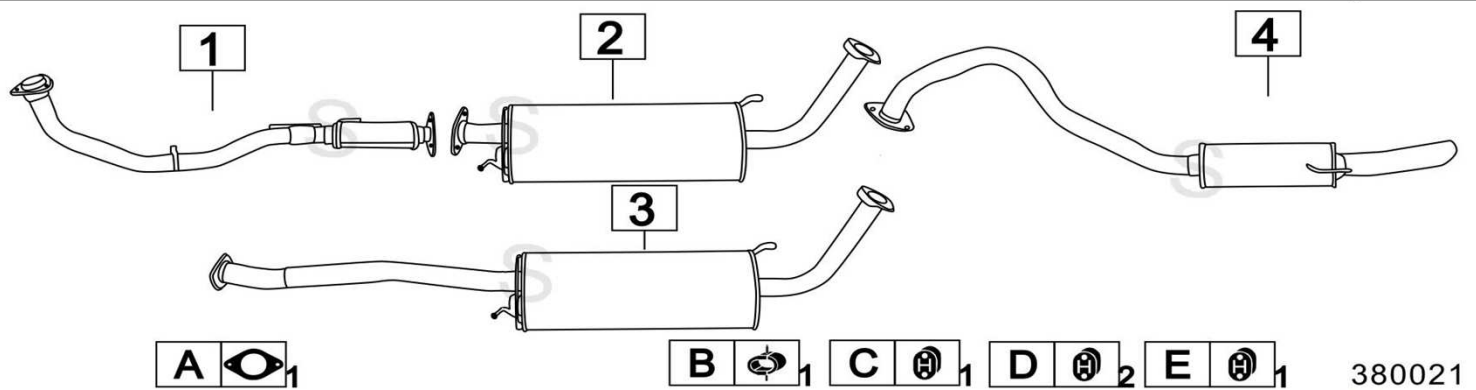

380021

	Codice	Descr.	O.E.	NOTE	Cod. Accessori
1	7515700	T C	2001034J00		A 2130930
2	7515776	M C	20110VB300	per 3 porte	B 2753902
3	7515766	M C	20100VB700	per 5 porte	C 2753911
4	7515807	M P	20350VB000		DE 2753911

NISSAN PATROL GR 3000 TURBO DIESEL 2953cc 116KW 6/99-

Codice	Descr.	O.E.	NOTE	Cod. Accessori
1	7515810	KAT	20800VC125-20800VC126	A 2753902
2	7515805	TI	20010VC000	B 2753911
3	7515806	MC	20100VC100	C 2753911
4	7515836	MC	20110VC000	D 2753911
5	7515807	MP	20350VB000	E

NISSAN PRAIRIE 2000 1974cc 73KW 10/88-

Codice	Descr.	O.E.	NOTE	Cod. Accessori
1	7512802	MA	2010035R00 - 2010035R01 - 2010035R25	A 2130933
2	7512809	GM	2010035R01	B 2743901
3				C 2333922

NISSAN PRAIRIE 2000 CATALIZZATA 1974cc 73KW 10/88-

Codice	Descr.	O.E.	NOTE	Cod. Accessori
1	7512800	TC	2001030R00	A 2130933
2	7512812	KAT	20802D5525 - 20802D5526 - 20802D5527	B 2743901
3	7512839	GM	2010030R10-2010030R11	C 2333922

NISSAN PRAIRIE 2000 CATALIZZATA 4WD 1974cc 73KW 10/88- 92

Codice	Descr.	O.E.	NOTE	Cod. Accessori
1	7512000	TC	2001040R20	A 2130933
2	7512016	KAT	2080043E27-2080243E27	BF 2753911
3	7512002	MA	2030045R00-2030045R01	C 2783910
4	7512006	MC	2003045R00-2003045R01	D 2750901
5	7512007	MP	2010042R00-2010042R01	E 2783910

NISSAN PRIMASTAR 1900 dCi M:F9Q 1870cc 30-74KW 7/02- 06

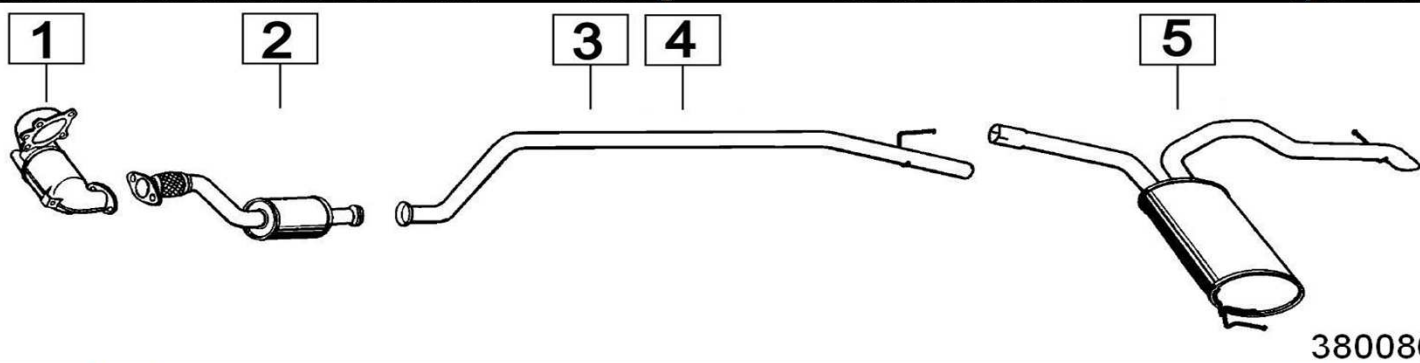

380086

	Codice	Descr.	O.E.	NOTE	Cod. Accessori
1	6265410	KAT	2080000QAC		A
2	6265402	M A	2001100QAA		B
3	6265403	T I	2003000QAA	Passo corto 3100	C
4	6265433	T I	2003000QAB	Passo lungo 3500	D
5	6265407	M P	2011000QAF		E

NISSAN PRIMASTAR 2500 dCi M:G9U 2464cc 99KW 1/06-

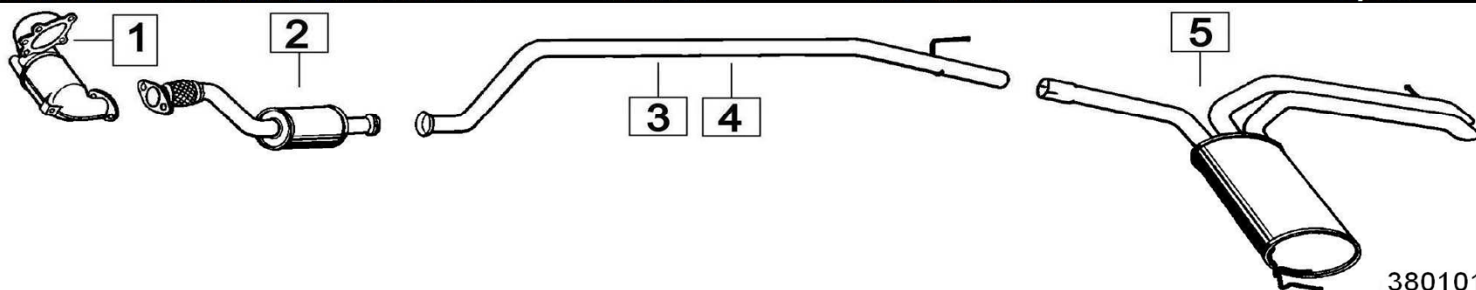

380101

	Codice	Descr.	O.E.	NOTE	Cod. Accessori
1	6267410	KAT	8200074746		A
2	6265416	M A	8200269607		B
3	6265603	T I	8200210915	Per passo corto 3098mm	C
4	6265633	T I	8200464254	Per passo lungo 3498mm	D
5	6265607	M P	8200311517		E

NISSAN PRIMERA 1600 16V 1597cc 70KW 2/90- 92

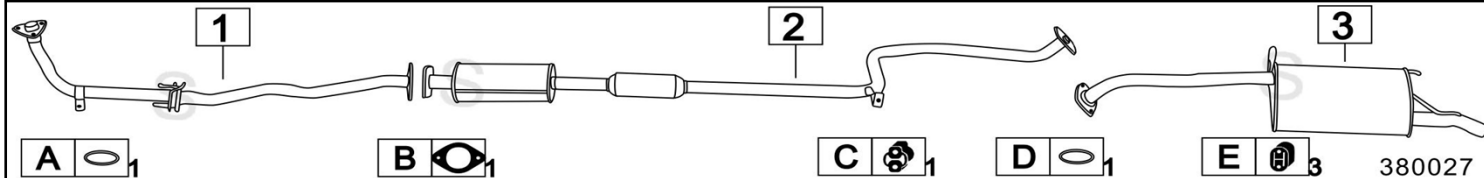

380027

	Codice	Descr.	O.E.	NOTE	Cod. Accessori
1	7507700	T C	2001070J00		AD 2791943
2	7507709	G M	2030070J00		B 2750907
3	7507707	M P	2010070J00		C 2783910
4					E 2791943

NISSAN PRIMERA 1600 16V CATALIZZATA 1597cc 66-71-75KW 6/90- 5/96

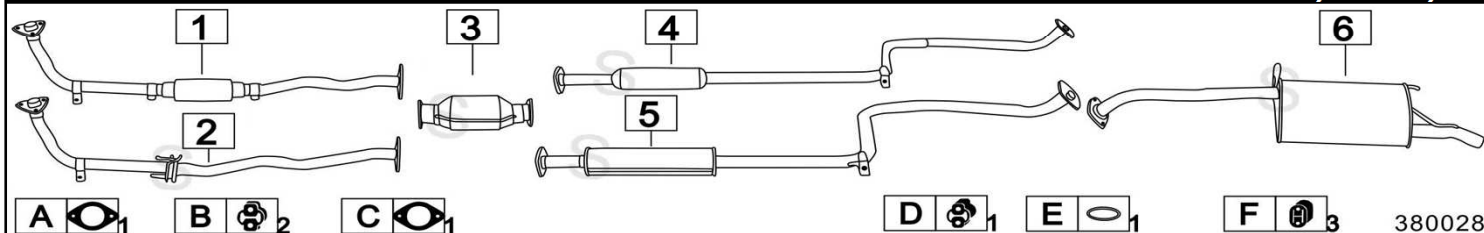

380028

	Codice	Descr.	O.E.	NOTE	Cod. Accessori
1	7507730	T C	2001070J10	fino al 04/1993	AC 2750907
2	7507740	T C	2001076J00	dal 05/1993	BD 2753903
3	7507712	KAT	208001N325 - 2080076J25		E 2791943
4	7507736	M C	2030070J10	fino al 04/1993	F 2743901
5	7507706	M C	2030076J00	dal 05/1993	
6	7507707	M P	2010070J00-2010076J00		

NISSAN PRIMERA 1600 16V S.W. 1597cc 70KW 6/90- 92

	Codice	Descr.	O.E.	NOTE	Cod. Accessori
1	7507700	T C	2001070J00		AD 2791943
2	7507409	G M	2030071N00		B 2750907
3	7507407	M P	2010071N00-2010071N01		C 2783910
4					E 2743901

NISSAN PRIMERA 1600 16V S.W. CATALIZZATA 1597cc 66-71-75KW 6/90- 97

	Codice	Descr.	O.E.	NOTE	Cod. Accessori
1	7507730	T C	2001070J10	fino al 04/1993	A 2750907
2	7507750	T C	2001071N10 - 2001071N00 - 2001095N00	dal 05/1993	B 2750907
3	7507712	KAT	208001N325 - 2080076J25		C 2753903
4	7507436	M C	2003071N10	fino al 04/1993	D 2753903
5	7507406	M C	2003088N00	dal 05/1993	E 2791943
6	7507407	M P	2010071N00-2010071N01		F 2743901

NISSAN PRIMERA 2000i / 2000i GT 16V 1998cc 89-110KW 2/90-92

	Codice	Descr.	O.E.	NOTE	Cod. Accessori
1	7507900	T C	2002072J01KE		A 2791945
2	7507930	T C	2002071J00-2002071J00KE	per GT 110KW	B 2750907
3	7507909	G M	2030071J00-2030071J00KE-2030071J01		C 2783910
4	7507907	M P	2010071J00		D 2791951
5					E 2743901

NISSAN PRIMERA 2000i/2000i GT 16V CATALIZZ. 1998cc 85-92-110KW 90- 5/96

	Codice	Descr.	O.E.	NOTE	Cod. Accessori
1	7507940	T C	2002072J11	fino al 04/1993	A 2791945
2	7507950	T C	2002071J10	per GT fino al 04/1993	B 2750907
3	7507960	T C	2001078J00	dal 05/1993	C 2750907
4	7507970	T C	2002078J10	per GT dal 05/1993	D 2753903
5	7507712	KAT	208001N325	fino al 04/1993	E 2783910
6	7526312	KAT	2080083J25	dal 05/1993	F 2791951
7	7507906	M C	2030071J10-2030071J11	fino al 04/1993	G 2743901
8	7507936	M C	2030078J00-2030078J10	dal 05/1993	H
9	7507907	M P	2010071J00-2010078J00		I

NISSAN PRIMERA 2000i 16V S.W. 1998cc 89KW 6/90- 92

Codice	Descr.	O.E.	NOTE	Cod. Accessori
1	7507900 T C	2002072J01KE		A 2791945
2	7507609 G M	2030081N00		B 2750907
3	7507607 M P	2010081N01-2010082N13		C 2783910
4				D 2791953

NISSAN PRIMERA 2000i 16V S.W. 1998cc 84-96KW 6/90- 97

Codice	Descr.	O.E.	NOTE	Cod. Accessori
1	7507940 T C	2002072J11	fino al 04/1993	A 2791945
2	7526400 T C	2001071N00 2002082N02 - 2002082N04	dal 05/1993	B 2750907
3	7530500 T C	2001097N00	dal 06/1996	C 2750907
4	7521112 KAT	2080074C28 - 2080040F28 - 2080040F25	fino al 05/1996	D 2753903
5	7507712 KAT	208001N325 - 2080076J25 - 2080073V26	dal 06/1996	E 2783910
6	7507636 M C	2003082N00 - 2003082N01 - B003M82N0AGA	fino al 04/1993	F 2791953
7	7507606 M C	2003082N00-2003082N11	dal 05/1993	G 2743901
8	7507607 M P	2010081N01-2010082N13		H

NISSAN PRIMERA 2000 DIESEL 1974cc 55KW 6/90- 5/96

Codice	Descr.	O.E.	NOTE	Cod. Accessori
1	7507800 T C	2002073J00		A 2791945
2	7507806 G M	2030077J00		B 2750907
3	7507807 M P	2010077J00		C 2783910
4				D 2791951
5				E 2743901

NISSAN PRIMERA 2000 DIESEL S.W. 1974cc 55KW 6/90- 97

Codice	Descr.	O.E.	NOTE	Cod. Accessori
1	7507830 T C	2002074N25-2002074N26		A 2791945
2	7507836 M C	2030074N01-2030074N25		B 2750907
3	7507837 M P	2010074N25		C 2783910
4				D 2791951
5				E 2743901

NISSAN PRIMERA II SERIE 1600 1597cc 66-75KW 6/96- 1/98

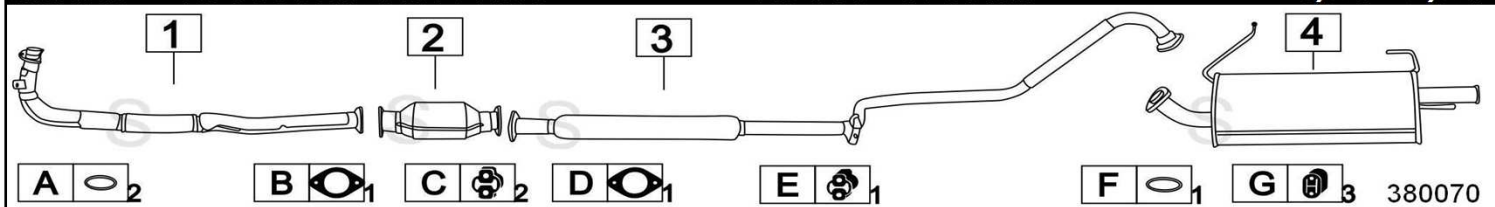

	Codice	Descr.	O.E.	NOTE	Cod. Accessori
1	7526800	T C	2001097N10		A 2791945
2	7526812	KAT	B080074C13		BD 2750907
3	7507436	M C	2003071N10		C 2753903
4	7507407	M P	2010071N00-2010071N01		E 2783910
5					F 2791953
6					G 2743901

NISSAN PRIMERA II SERIE 1600 1597cc 66-73-78KW 6/96-

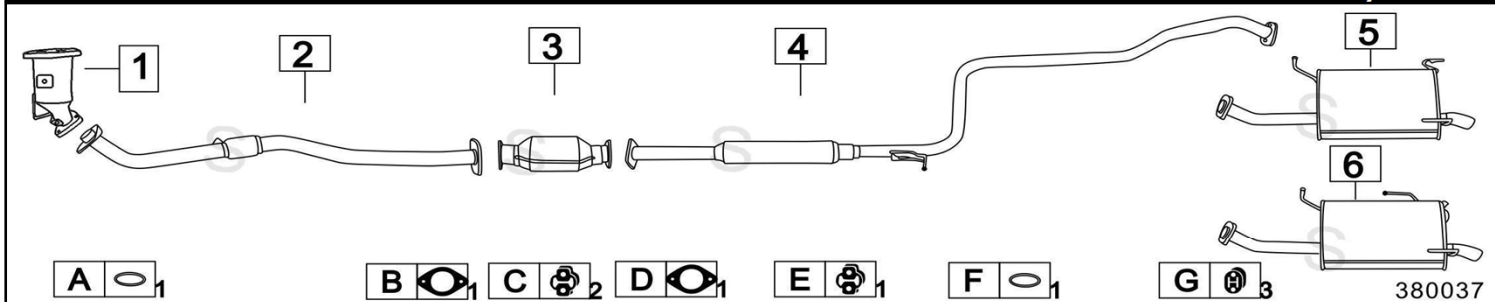

	Codice	Descr.	O.E.	NOTE	Cod. Accessori
1	7507010	KAT	208A02F000		A 2791943
2	7507000	T C	200103J300-200103J300KE		BD 2750907
3	7507712	KAT	208001N325-2080070J25		CE 2753903
4	7507006	M C	203003J300-203003J300KE		F 2791945
5	7507007	M P	201003J300-201003J300KE	per 4/5 porte	G 2753911
6	7507037	M P	201008F800-201008F800KE	per S.W.	

NISSAN PRIMERA II SERIE 1600/1800 Euro 3-4 1597-1769cc 78-82KW 00- 01/02

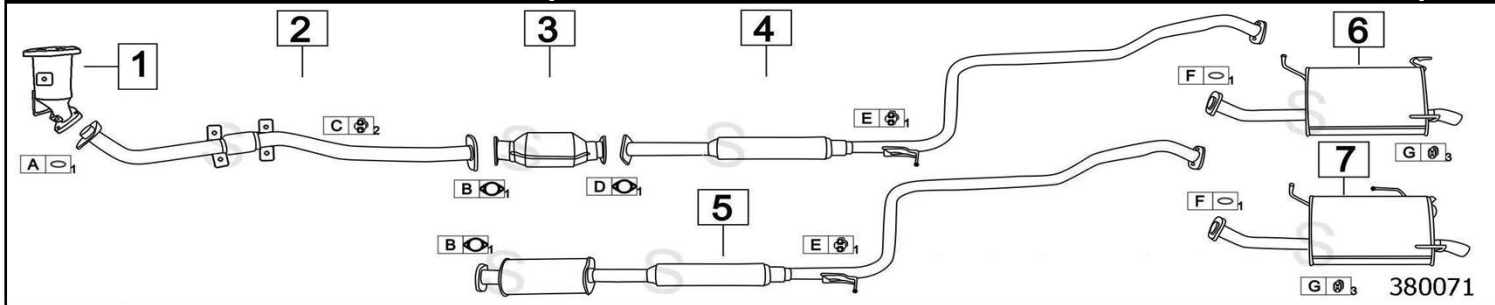

	Codice	Descr.	O.E.	NOTE	Cod. Accessori
1	7530310	KAT	B08A09F600		A 2791943
2	7530300	T C	200109F600 200109F600KE		B 2750907
3	7530316	KAT	208023J325	per Euro4	C 2753903
4	7530306	M C	203007J600	per Euro4	D 2750907
5	7530309	M C	203009F600 203009F600KE	per Euro3	E 2753903
6	7507207	M P	201003J400KE	per 4/5 porte	F 2791945
7	7507237	M P	201008F400KE	per S.W.	G 2753911

NISSAN PRIMERA II SERIE 2000 16V 1998cc 85-96KW 6/96-

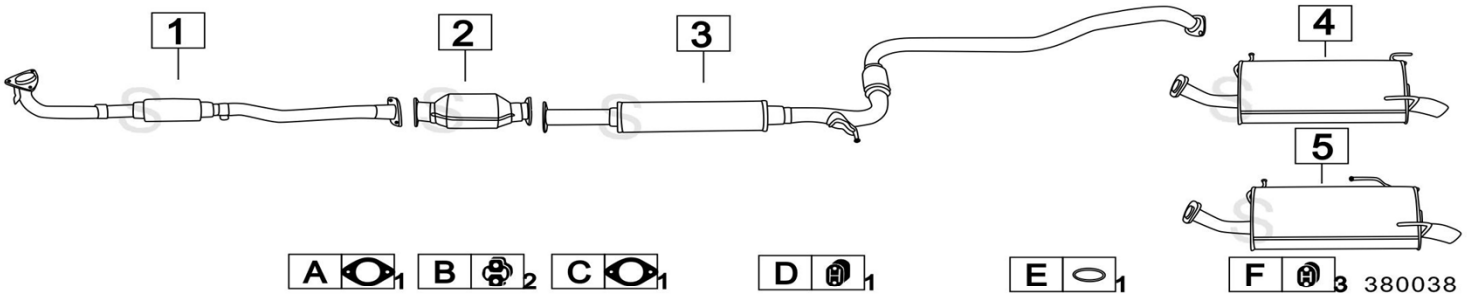

	Codice	Descr.	O.E.	NOTE	Cod. Accessori
1	7507200	T C	200103J400KE		AC 2750907
2	7507712	KAT	208001N325-2080070J25		B 2753903
3	7507209	G M	203003J400KE		D 2743901
4	7507207	M P	201003J400KE	per 4/5 porte	E 2791945
5	7507237	M P	201008F400KE	per S.W.	F 2753911

NISSAN PRIMERA II SERIE 2000 16V GT 1998cc 110KW 6/96-

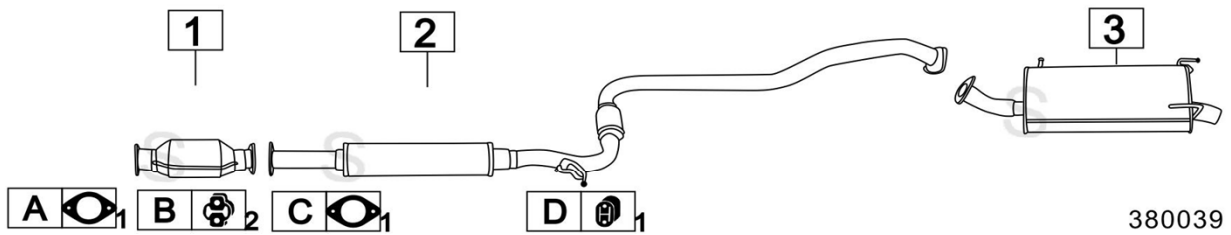

	Codice	Descr.	O.E.	NOTE	Cod. Accessori
1	7507712	KAT	208001N325-2080070J25		AC 2750907
2	7507509	G M	203003J410		B 2753903
3	7507507	M P	201003J410-201003J410KE		D 2743901

NISSAN PRIMERA II SERIE 2000 TURBO DIESEL 1974cc 66KW 6/96-

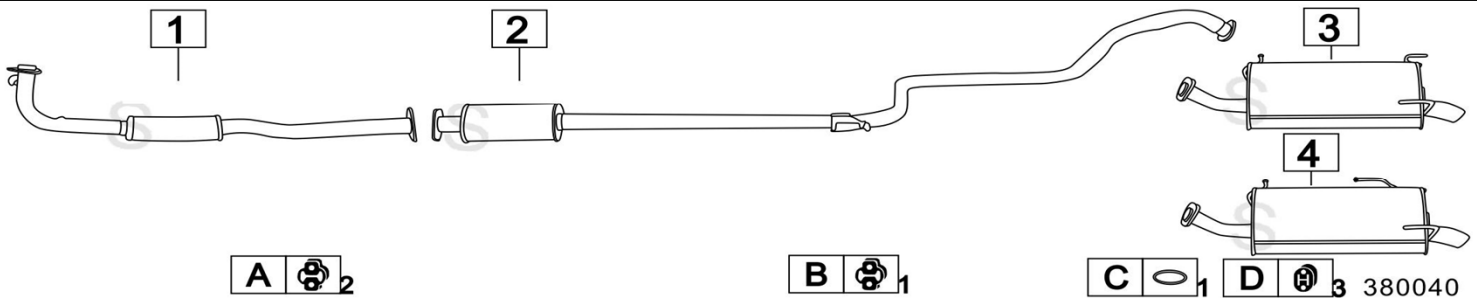

	Codice	Descr.	O.E.	NOTE	Cod. Accessori
1	7502700	T C	200103J500KE		A 2753903
2	7502706	M C	203003J500KE		B 2753903
3	7507207	M P	201003J400KE	per 4/5 porte	C 2791945
4	7507237	M P	201008F400KE	per S.W.	D 2753911

NISSAN QASHQAI 1600 16V 2WD 1598cc 84KW 12/06-

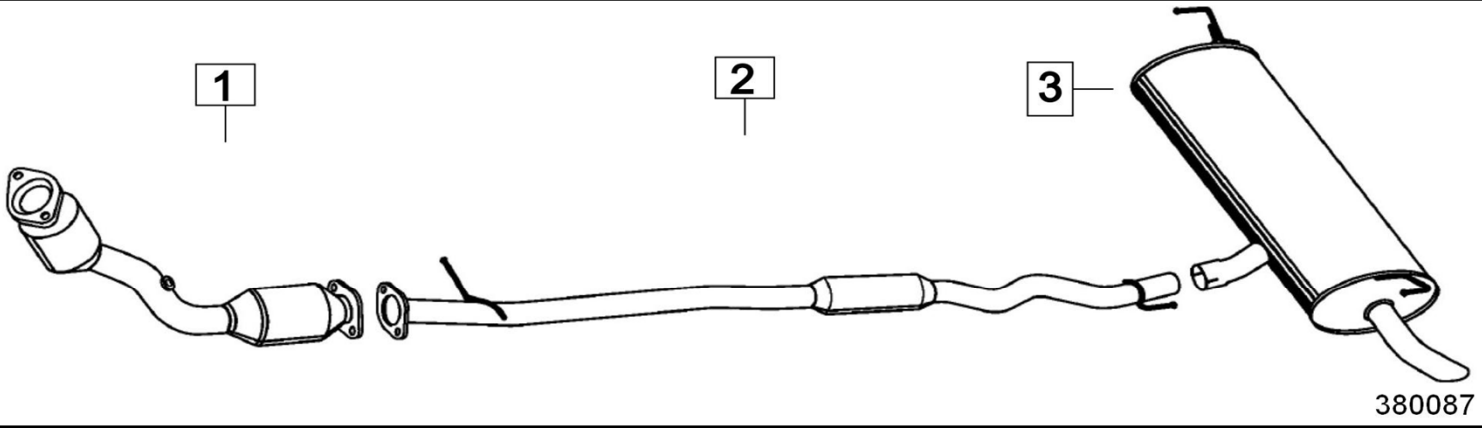

	Codice	Descr.	O.E.	NOTE	Cod. Accessori
1	7500012	KAT	20010JD000		A
2	7500006	M C	20100JD00A - 20100JD21A		B
3	7500007	M P	20100JD00A - 20100JD21A		C

NISSAN QASHQAI 2000 16V 2WD - 4WD 1997cc 104KW 12/06-

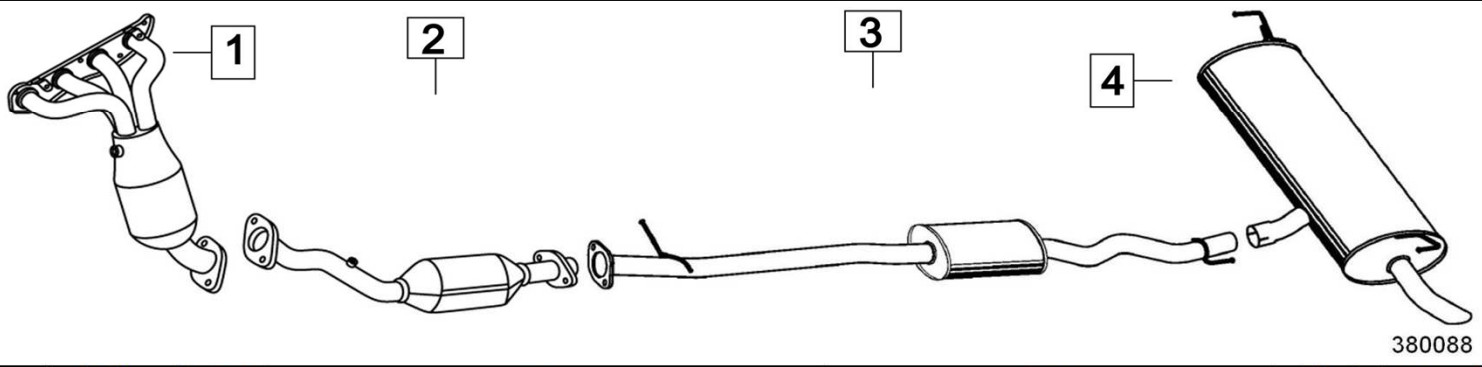

	Codice	Descr.	O.E.	NOTE	Cod. Accessori
1	7500010	KAT	14002JD90A		A
2	7500016	KAT	20010JD200		B
3	7500036	M C	20100JD200		C
4	7500037	M P	20100JD200		D

NISSAN QASHQAI 1500 DCi DPF Mot: K9K 2WD 1461cc 76-78KW 8/08- 1/10

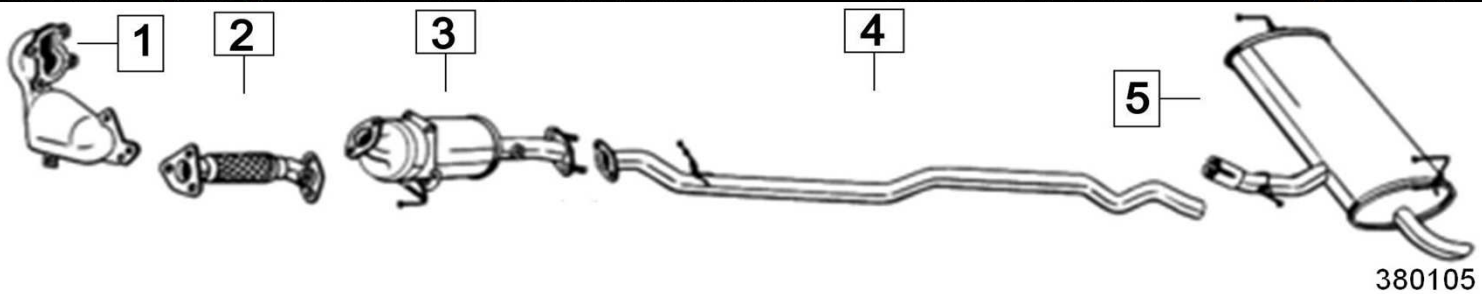

	Codice	Descr.	O.E.	NOTE	Cod. Accessori
1	7500210	KAT	2090000Q0C		A
2	7500205	T A	20010JD51A		B
3	7500226	FAP			C
4	7500204	T I	20100EY10D		D
5	7500207	M P	20100EY10D		E

NISSAN QASHQAI 1500 DCi DPF Mot: K9K 2WD 1461cc 76-78KW 8/08- 1/10



1

380111

	Codice	Descr.	O.E.	NOTE	Cod. Accessori
1	7500326	FAP	20800JD50B		A

NISSAN QASHQAI 1500 DCi DPF Mot: K9K 2WD EURO5 1461cc 82KW 1/10-



1

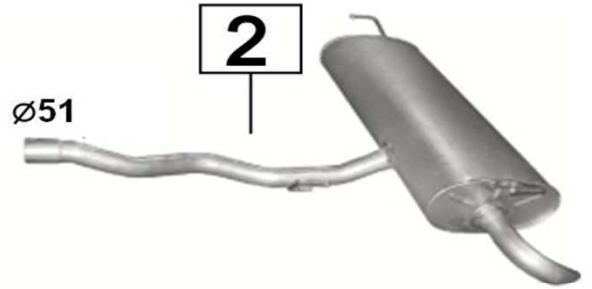

2

ø51

380112

	Codice	Descr.	O.E.	NOTE	Cod. Accessori
1	7500426	FAP	20010BB30A		A
1	7500447	M P	20100JD500		A

NISSAN QASHQAI 2000 DCi DPF 2WD / 4WD 1995cc 78KW 12/06-

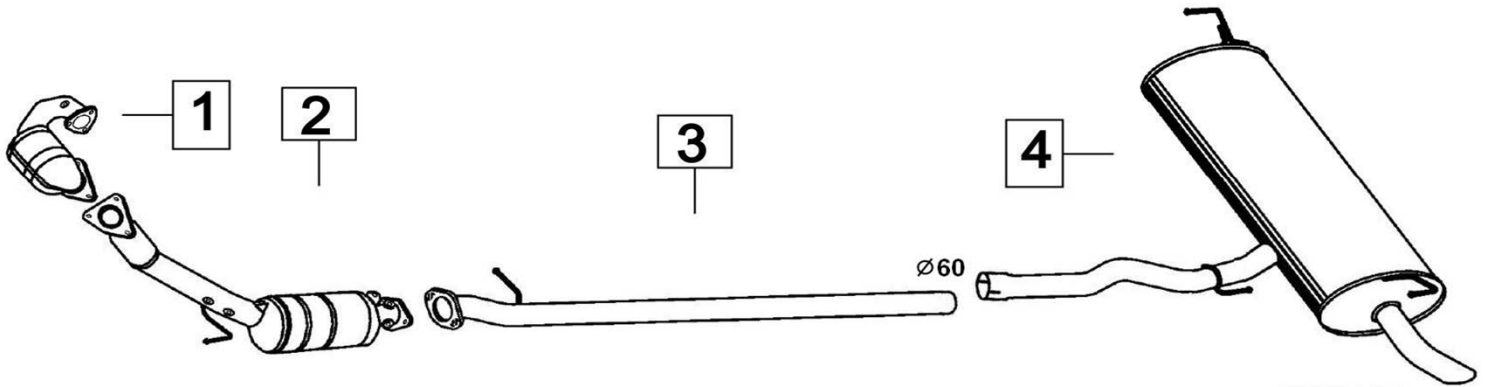

1

2

3

4

ø60

380104

	Codice	Descr.	O.E.	NOTE	Cod. Accessori
1	7500110	KAT	208A0JD50A		A
2	7500022	FAP	20100JD71B		B
3	7500004	T I	20100BR21A 20100BR20A		C
4	7500047	M P	20100BR21A 20100BR20A		D

NISSAN SERENA 1600 16V 1597cc 74KW 92- 95

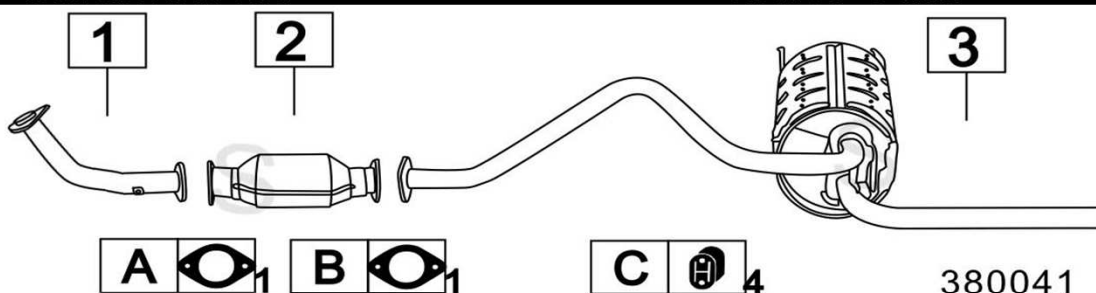

	Codice	Descr.	O.E.	NOTE	Cod. Accessori
1	7517200	T C	200108C800		A 2750907
2	7507712	KAT	208001N325-2080070J25-2080074C28		B 2750907
3	7517207	M P	201009C000-201009C703		C 2743901

NISSAN SERENA 2000 16V 1998cc 93KW 10/92- 96

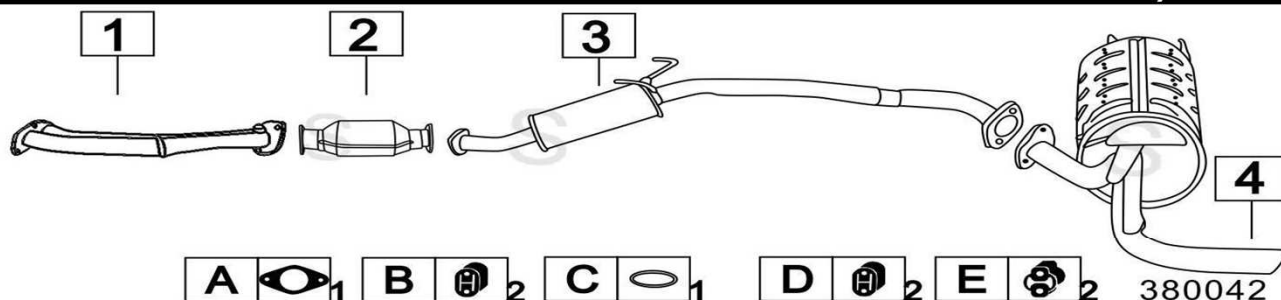

	Codice	Descr.	O.E.	NOTE	Cod. Accessori
1	7512700	T C	200109C100		A 2130933
2	7512712	KAT	208022C625 - 208022C600		BD 2743901
3	7512706	M C	203509C100		C 2791945
4	7512707	M P	201009C101		E 2783910

NISSAN SERENA 200/2300 DIESEL 1952-2283cc 49-55KW 10/92-

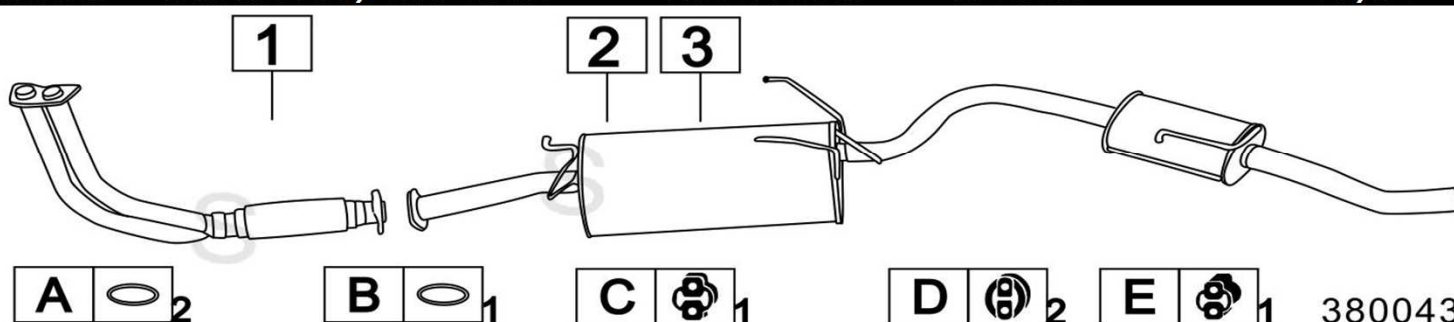

	Codice	Descr.	O.E.	NOTE	Cod. Accessori
1	7512600	T C	200109C002		A 2791943
2	7512609	G M	201009C001		B 2791951
3	7512639	G M	201009C600	per 2300 CARGO	C 2753903
4					D 2713903
5					E 2783910

NISSAN SUNNY 1200 120Y Mot: A12 1171cc 38KW 78- 4/82

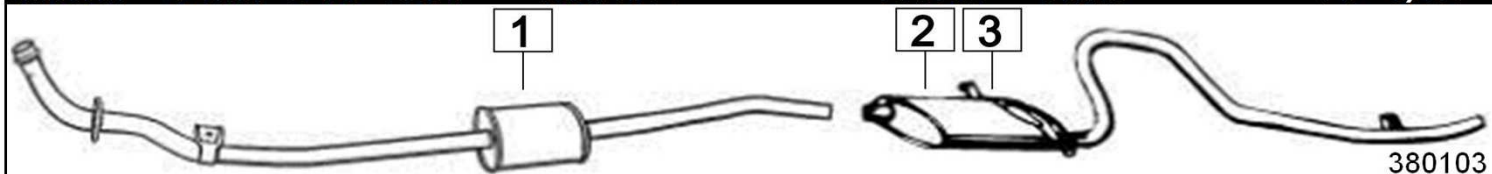

	Codice	Descr.	O.E.	NOTE	Cod. Accessori
1	7523402	M A	20010H8800KE		A
2	7523407	M P	20100H9100 20100H9100KE	per Coupè	B
3	7523507	M P	20100H9600	per S.W.	C

NISSAN TERRANO 2400 i CATALIZZATO 2387cc 76KW 7/86- 92

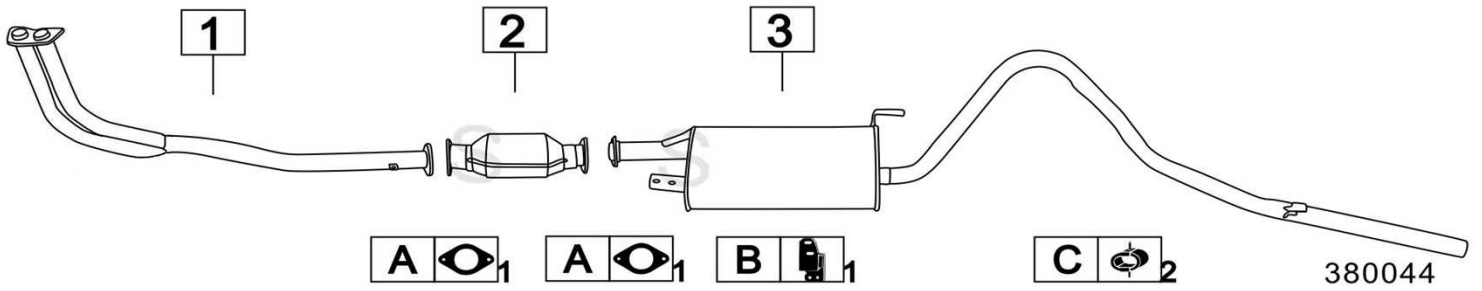

380044

	Codice	Descr.	O.E.	NOTE	Cod. Accessori
1	7541500	T C	200200F300 - 200200F350		A 2130930
2	7541512	KAT	208020F325 - 208020F327		B 2133917
3	7516807	M P	2010041G15-2010041G15KE	per 3 / 5 porte	C 2753902

NISSAN TERRANO 3000i V6 CATALIZZATO 2960cc 109KW 5/90- 92

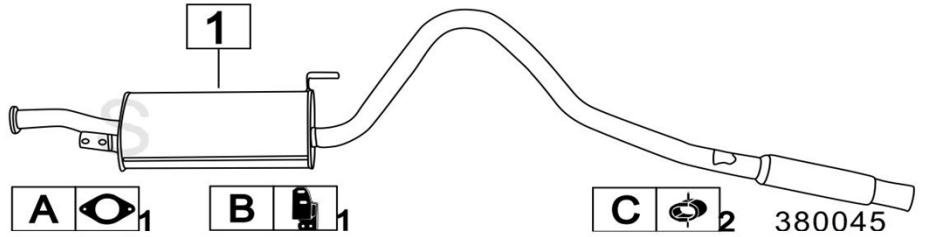

380045

	Codice	Descr.	O.E.	NOTE	Cod. Accessori
1	7516007	M P	2010088G22	per 3 / 5 porte	A 2130930
2					B 2133917
3					C 2753902

NISSAN TERRANO 2700 TURBO DIESEL 3 PORTE 88- 3/93

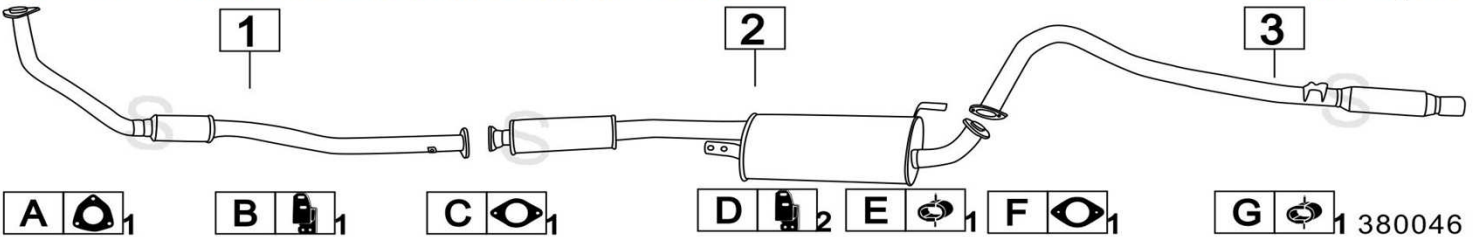

380046

	Codice	Descr.	O.E.	NOTE	Cod. Accessori
1	7516200	T C	200107F002		A 2130932
2	7516509	G M	2010080G07KE		BD 2133917
3	7516508	T P	2005080G07		C 2130930
4					EG 2753902
5					F 2130922

NISSAN TERRANO II SERIE 2400 Mot:K24E/KA24E 2389cc 91KW 4/93- 9/99

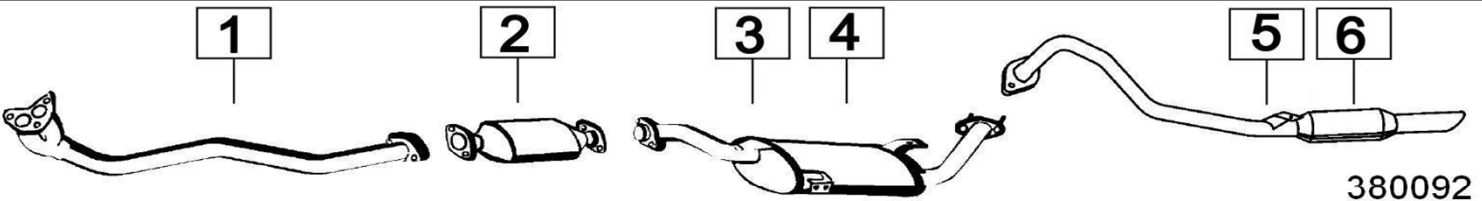

380092

	Codice	Descr.	O.E.	NOTE	Cod. Accessori
1	7541500	T C	200200F300 - 200200F350		A
2	7541512	KAT	208020F325 - 208020F327		B
3	7541506	M C	201000F350 - 201007F250	per 3 porte - passo corto 2450mm	C
4	7541606	M C	201000F850 - 201007F850	per 5 porte - passo lungo 2650mm	D
5	7541508	M P	200500F300 - 200500F350 - 200507F250	per 3 porte - passo corto 2450mm	E
6	7541608	M P	200500F800 - 200500F850 - 200507F850	per 5 porte - passo lungo 2650mm	F

NISSAN TERRANO II SERIE 2700 TURBO DIESEL 2664cc 74-92KW 4/93- 8/99

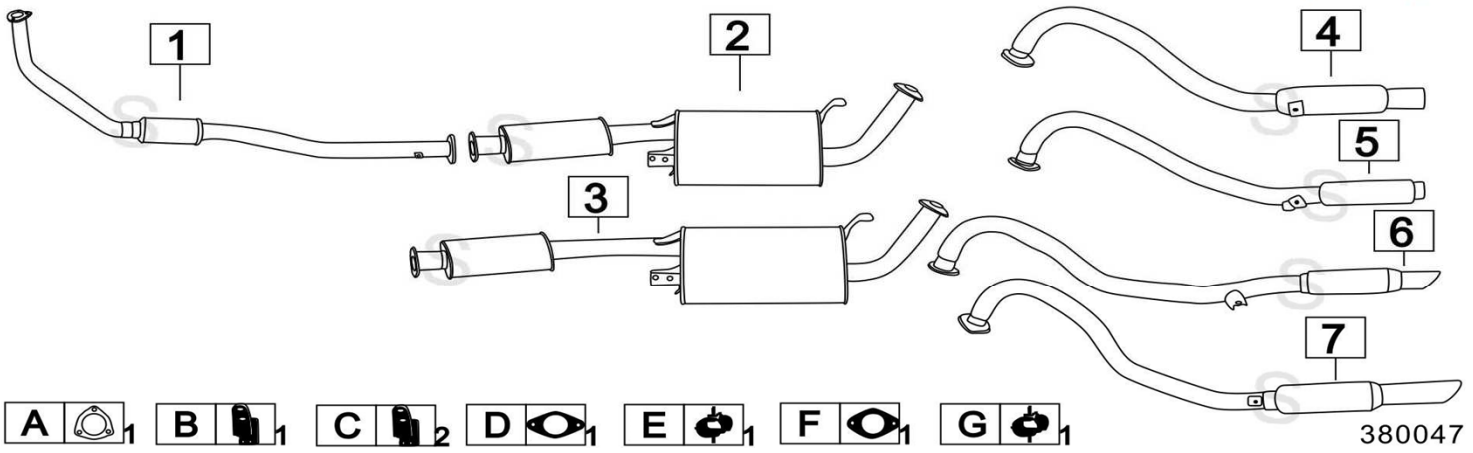

380047

	Codice	Descr.	O.E.	NOTE	Cod. Accessori
1	7516200	T C	1958430-1960314		A 2130932
2	7516209	G M	1960321	per 3 porte - passo corto	B 2133917
3	7516239	G M	1956102-1960323	per 5 porte - passo lungo	C 2133917
4	7516208	M P	1958432	per 3 porte - passo corto	D 2130930
5	7516248	M P	1960317	per 3 porte - passo corto dal 8/1996	E 2753902
6	7516238	M P	1958434	per 5 porte - passo lungo	F 2130922
7	7516258	M P	1960319	per 5 porte - passo lungo dal 8/1996	G 2753902

NISSAN TERRANO II SERIE 2700 TURBO DIESEL 2664cc 92KW 9/99-

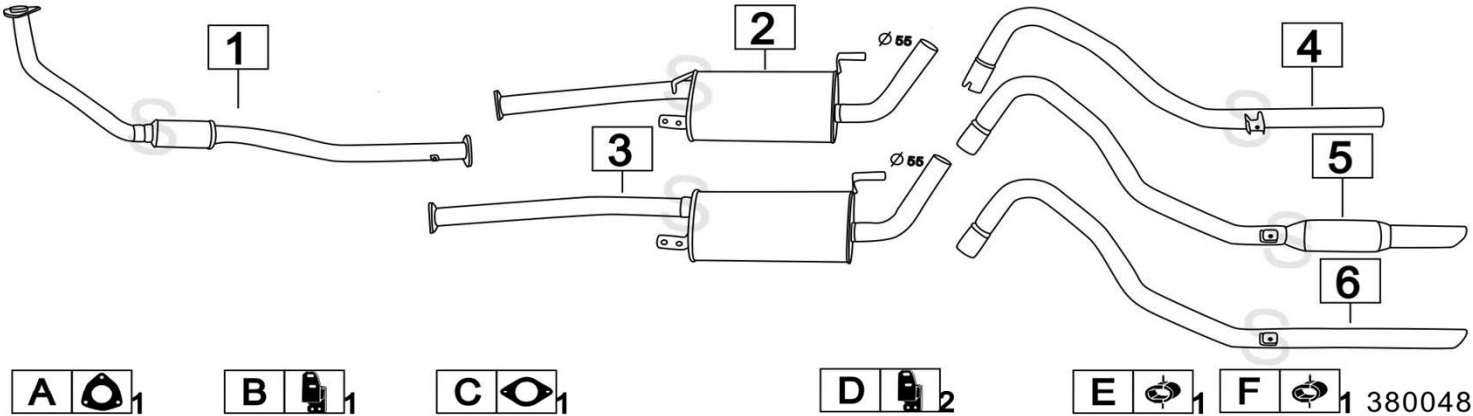

380048

	Codice	Descr.	O.E.	NOTE	Cod. Accessori
1	7516200	T C	200107F002		A 2130932
2	7516106	M C	201007F053	per 3 porte - passo corto	B 2133917
3	7516136	M C	201007F654	per 5 porte - passo lungo	C 2130930
4	7516108	T P	200507F053	per 3 porte - passo corto	D 2133917
5	7516107	M P	200507F652	per 5 porte - passo lungo	E 2753902
6	7516138	T P	200507F6A3	per 5 porte - passo lungo dal 9/2001	F

NISSAN TERRANO II SERIE 3000 Di TURBO DIESEL 2953cc 113KW 4/02-

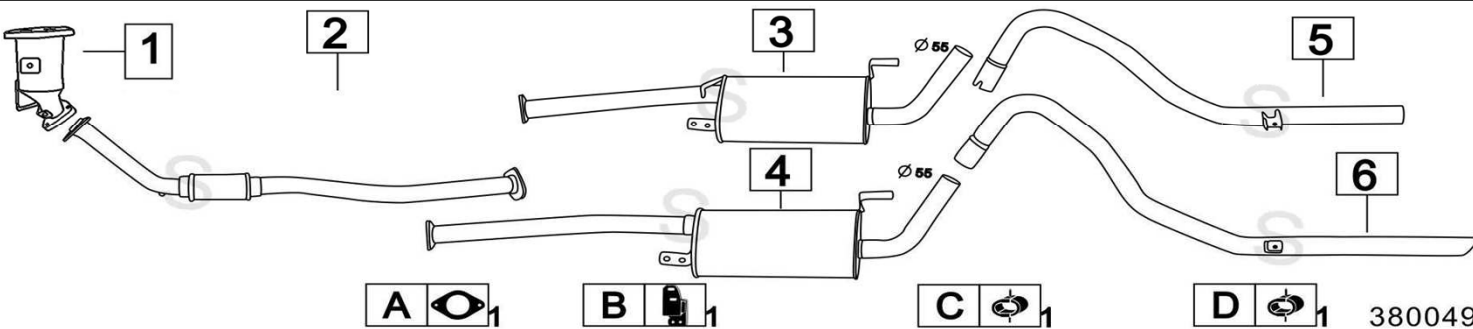

380049

	Codice	Descr.	O.E.	NOTE	Cod. Accessori
1	7516610	KAT	B0800VR800		A 2130930
2	7516600	T C	200102X900		B 2133917
3	7516606	M C	201002X950	per 3 porte - passo corto	C 2753902
4	7516636	M C	201002X951	per 5 porte - passo lungo	D 2753902
5	7516108	T P	200507F053	per 3 porte - passo corto	E
6	7516138	T P	200507F6A3	per 5 porte - passo lungo	F

NISSAN TRADE 2000 FURGONE

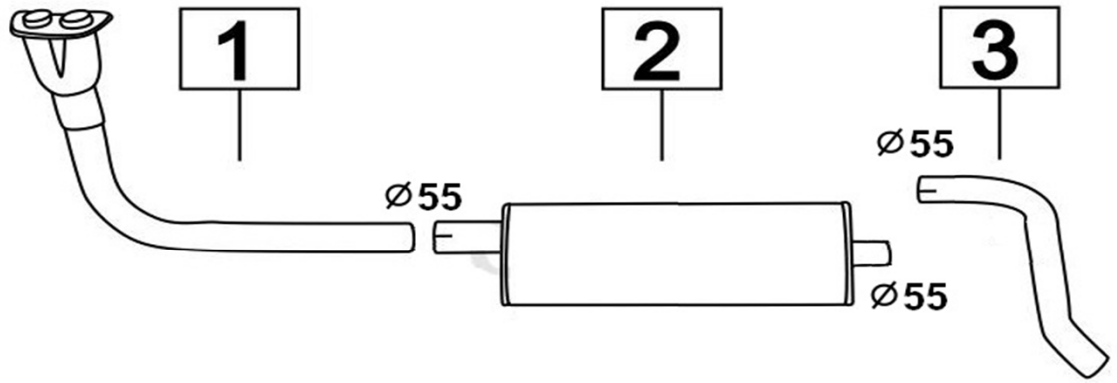

380117

	Codice	Descr.	O.E.	NOTE	Cod. Accessori
1	7527800	T C	091051461		A
2	7545506	M C	091004170 - 091006860 - 091006861		B
3	7527804	T P	091051431		C

NISSAN TRADE 2000 BENZINA / DIESEL

90-

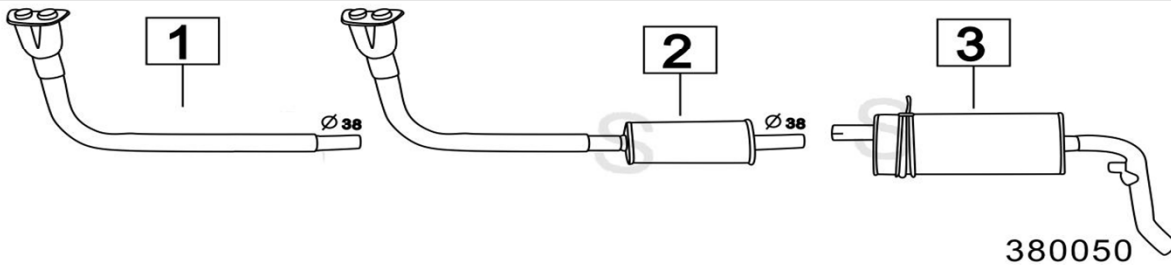

380050

	Codice	Descr.	O.E.	NOTE	Cod. Accessori
1	7516700	T C	091052290	per Diesel	A
2	7516702	M A	091051920	per Benzina	B
3	7516707	M P	091051860		C

NISSAN TRADE 2500 / 2800 DIESEL

90-

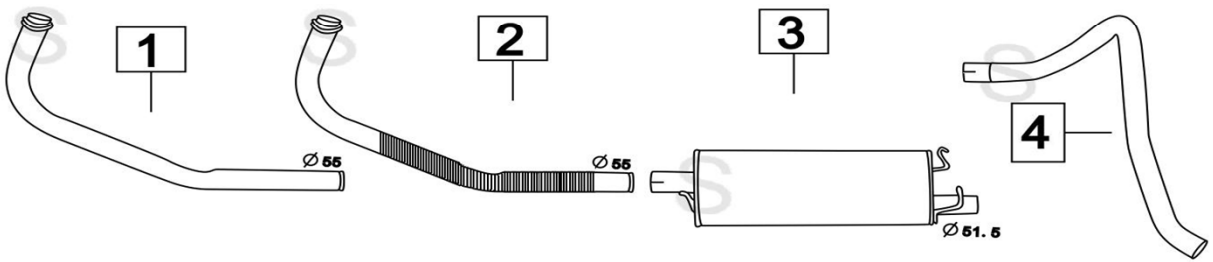

380051

	Codice	Descr.	O.E.	NOTE	Cod. Accessori
1	7516400	T C	091052010 - 091052011		A
2	7516430	T C	091052010 - 091052011	modifica con flessibile	B
3	7516406	M C	01052021		C
4	7516408	T P	091052070		D

NISSAN TRADE L 35 3000 DIESEL 2953cc 63KW 4/93-

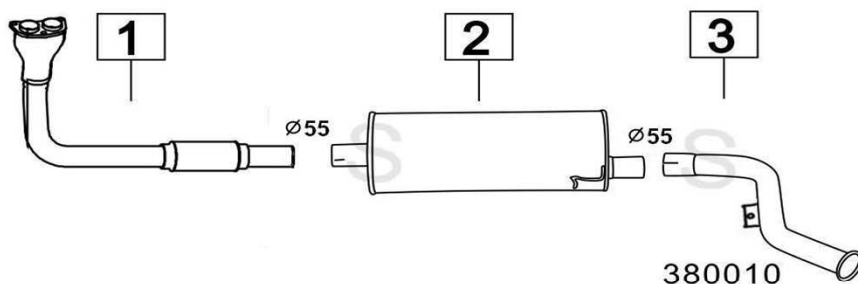

	Codice	Descr.	O.E.	NOTE	Cod. Accessori
1	7537000	T C	20020D8600		A
2	7537006	M C	09101201-0		B
3	7537008	T P	09101197-0		C

NISSAN TRADE L 35 3000 DIESEL 2953cc 63KW 10/95-

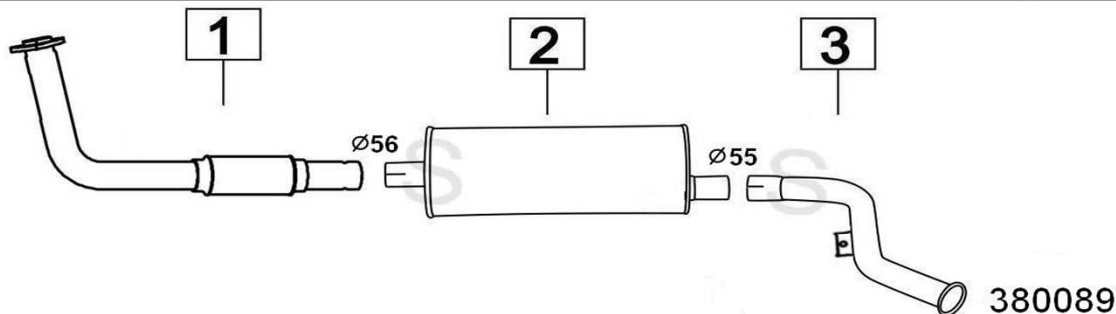

	Codice	Descr.	O.E.	NOTE	Cod. Accessori
1	7537100	T C	20010G4800		A
2	7537106	M C	20100G4800		B
3	7537008	T P	09101197-0		C

NISSAN URVAN 2000 BZ- 2300/2500 D 1952-2289-2494cc 64-51-59KW 6/87- 94

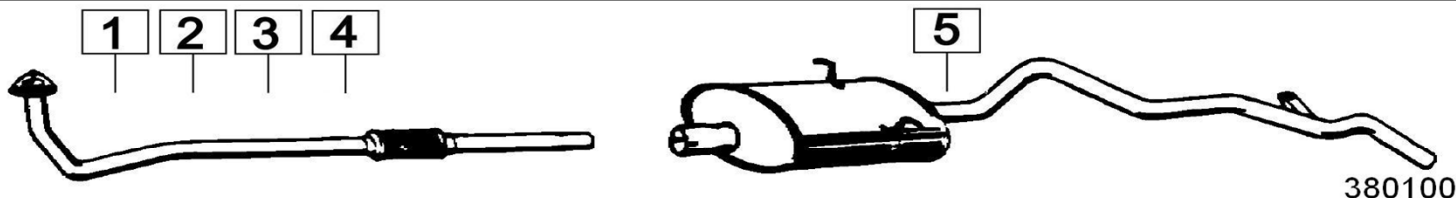

	Codice	Descr.	O.E.	NOTE	Cod. Accessori
1	7501200	T C	2001001N06	per 2000 benzina passo corto	A
2	7501230	T C	2001001N66	per 2000 benzina passo lungo	B
3	7501240	T C	2001002N07	per Diesel passo corto	C
4	7501250	T C	2001002N68	per Diesel passo lungo	D
5	7501207	M P	B010M01NOG		E

NISSAN VANETTE 1500 (produzione spagnola) 1488cc 51KW 4/87-

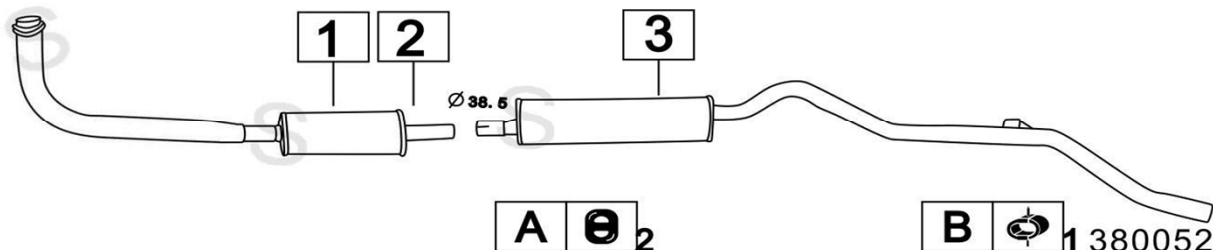

	Codice	Descr.	O.E.	NOTE	Cod. Accessori
1	7501102	M A	20010Y9501 - 20010G2515 - 20010G4000		A 2123904
2	7501132	M A	20010Y9602	per passo lungo dal 1991	B 2753902
3	7501107	M P	20090Y9501		C

NISSAN VANETTE 1600 16V CATALIZZATO 1597cc 71KW 9/94-

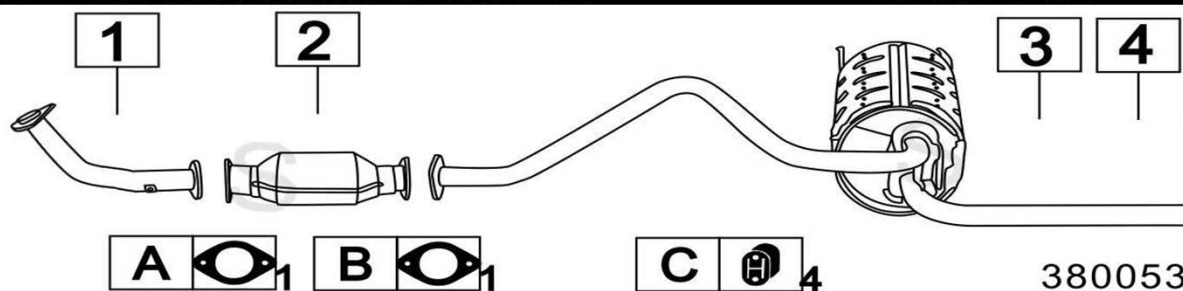

	Codice	Descr.	O.E.	NOTE	Cod. Accessori
1	7517200	T C	200108C800		A 2130933
2	7507712	KAT	208001N325-2080070J25-2080074C28		B 2743901
3	7517207	M P	201009C000-201009C703		C
4	7517237	M P	201009C704	per CARGO	D

NISSAN VANETTE 2000 DIESEL 1952cc 45KW 4/87-

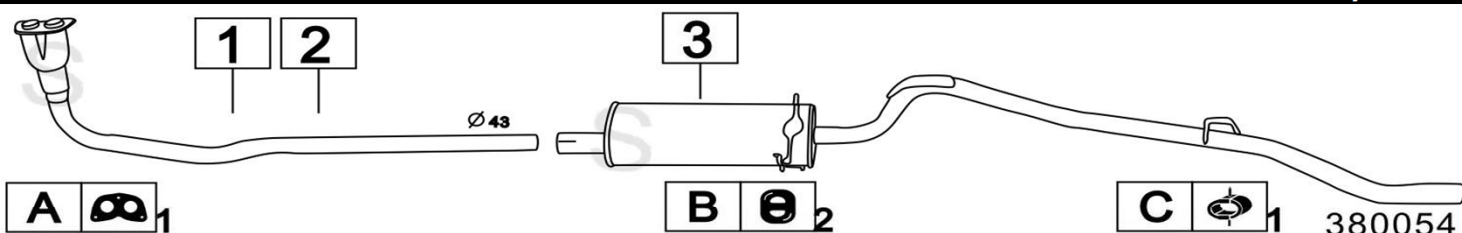

	Codice	Descr.	O.E.	NOTE	Cod. Accessori
1	7501800	T C	20010Y9604	passo corto	A 2750902
2	7501830	T C	20010Y9605	passo lungo	B 2123904
3	7501807	M P	20090Y9600-20090Y9650		C 2753902

NISSAN VANETTE 2000 DIESEL Mot. LD20 (made in Japan) 1952cc 47KW 10/86- 93

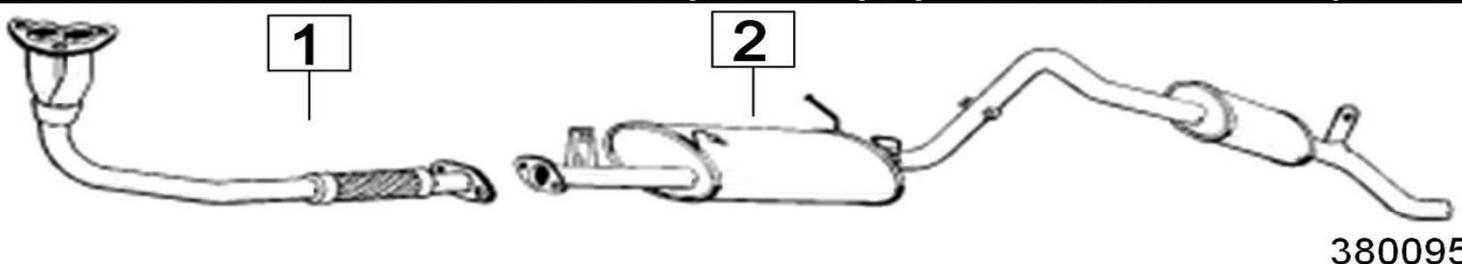

	Codice	Descr.	O.E.	NOTE	Cod. Accessori
1	7527600	T C	2001014C11		A
2	7527609	G M	2010014C23 2010014C12		B

NISSAN VANETTE 2300 DIESEL 2283cc 55KW 95-

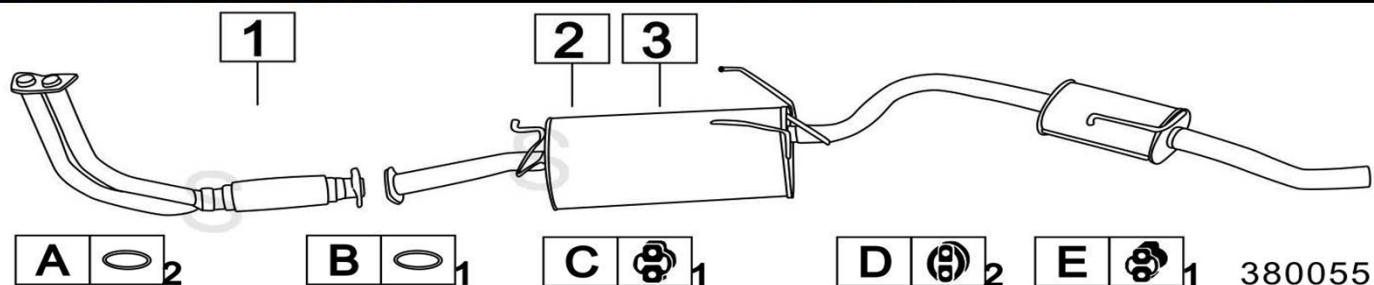

	Codice	Descr.	O.E.	NOTE	Cod. Accessori
1	7512600	T C	200109C002		A 2791943
2	7512609	G M	201009C001		B 2791951
3	7512639	G M	201009C600	per CARGO	C 2753903

NISSAN X-TRAIL 2000 / 2500 16V 1998-2488cc 103-121KW 7/01-

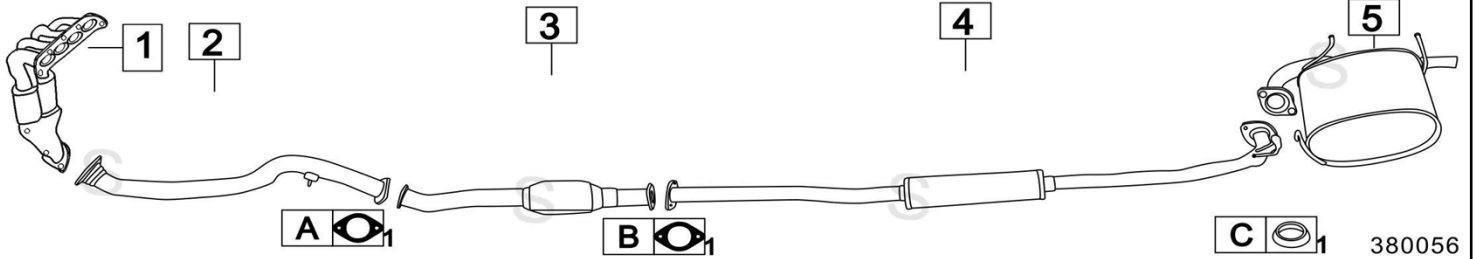

380056

	Codice	Descr.	O.E.	NOTE	Cod. Accessori
1	7511810	KAT	140029Y900		A 2750907
2	7511800	T C	200108H700		B 2750907
3	7504516	KAT	200188H700		C 2121955
4	7511806	M C	203008H300		D
5	7511807	M P	201008H700		E

NISSAN X-TRAIL 2200 Di TURBO DIESEL 2184cc 84KW 9/01-

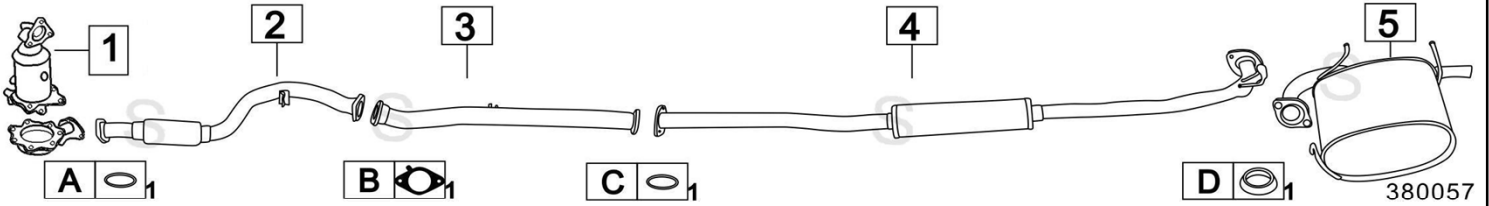

380057

	Codice	Descr.	O.E.	NOTE	Cod. Accessori
1	7511312	KAT	B08A08H825		A 2791951
2	7511300	T C	200108H800		B
3	7511305	T I	200188H800		C 2791951
4	7511306	M C	203008H800		D 2121955
5	7511807	M P	201008H700		E

NISSAN X-TRAIL 2200 DCi TURBO DIESEL 2184cc 100KW 12/03-

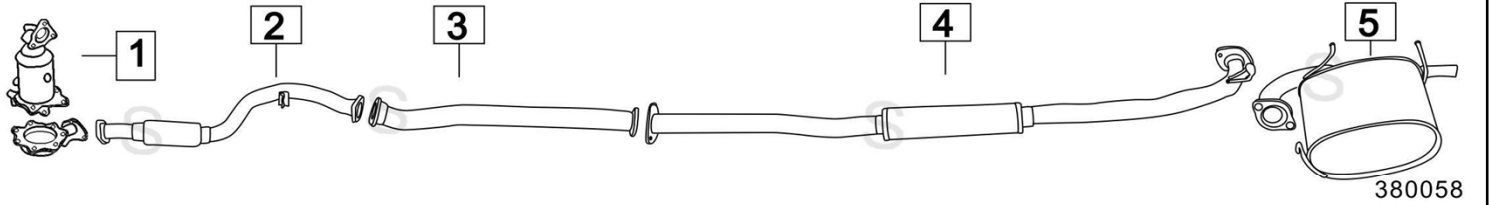

380058

	Codice	Descr.	O.E.	NOTE	Cod. Accessori
1	7511012	KAT	B08A0AU605		A
2	7511300	T C	200108H800		B
3	7511005	T I	200188H810		C
4	7511006	M C	203008H600		D
5	7511007	M P	201008H810		E